

---





Fig.1 Gate-Charge Characteristics

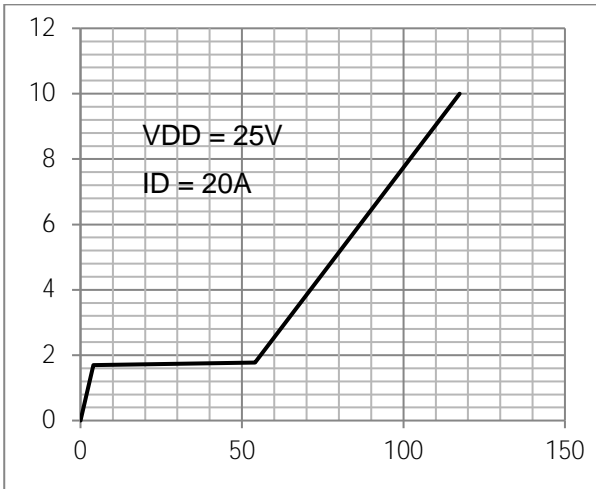

Fig.2 Capacitance Characteristics

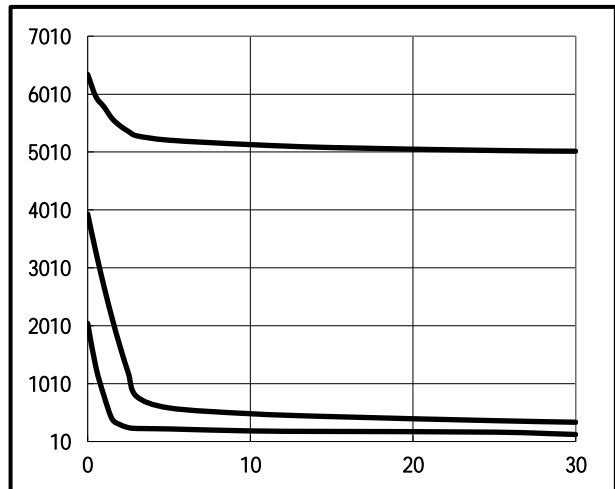

Fig.3 Power Dissipation

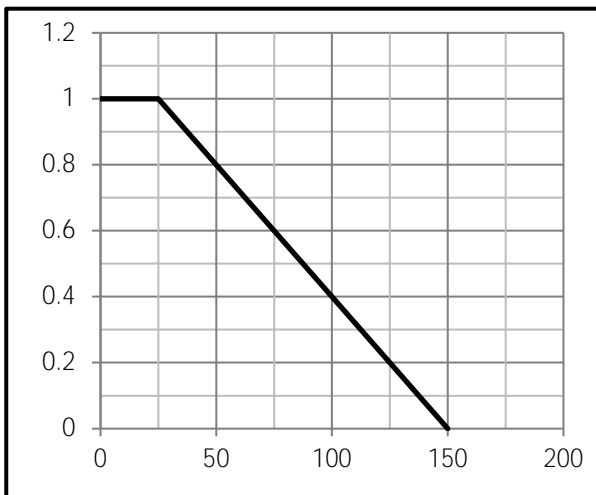

Fig.4 Typical output Characteristics

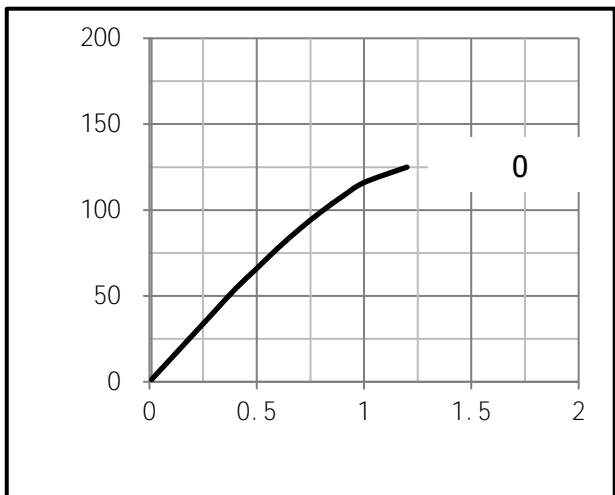

Fig.5 Threshold Voltage V.S Junction Temperature

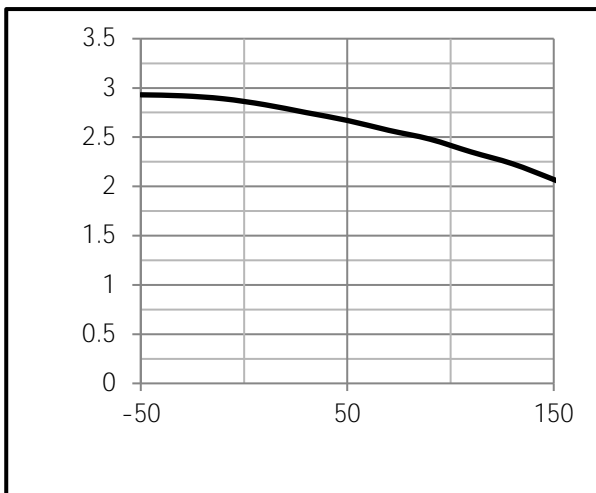
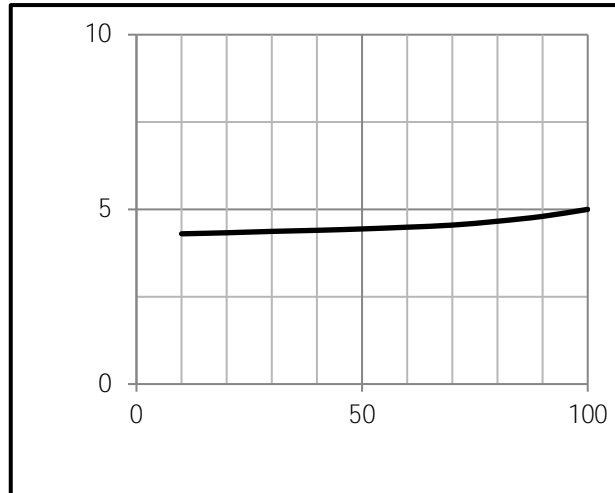

Fig.6 Resistance V.S Drain Current





-6

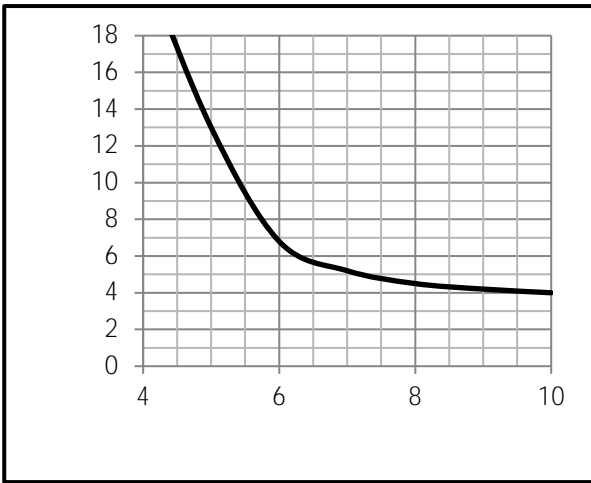
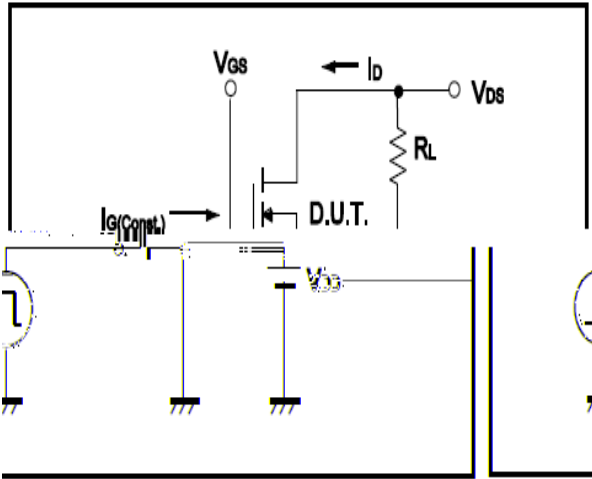

Fig.9 Switching Time Measurement Circuit



-7

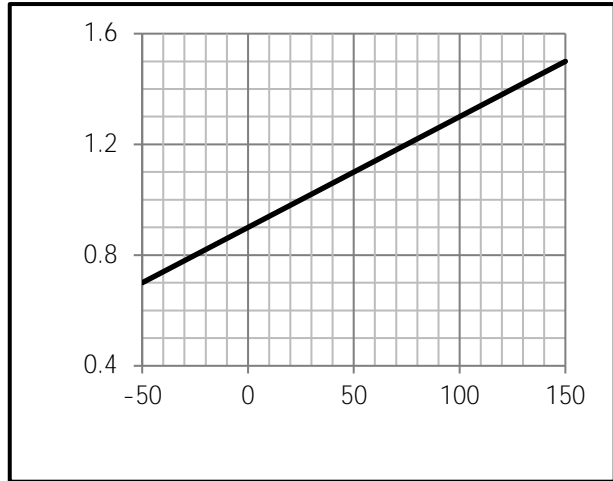

Fig.10 Gate Charge Waveform

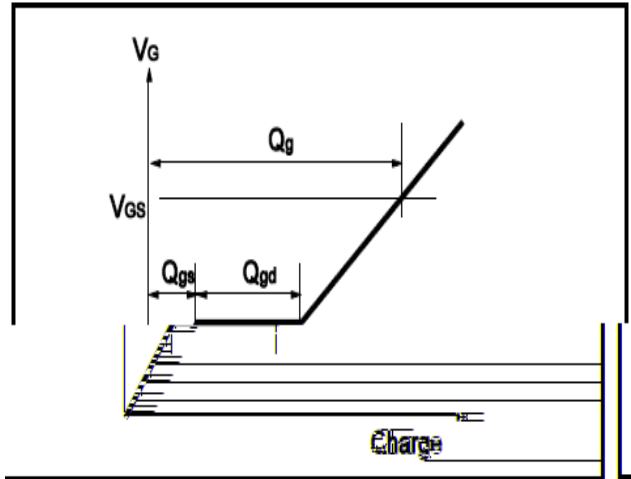

Fig.11 Switching Time Measurement Circuit

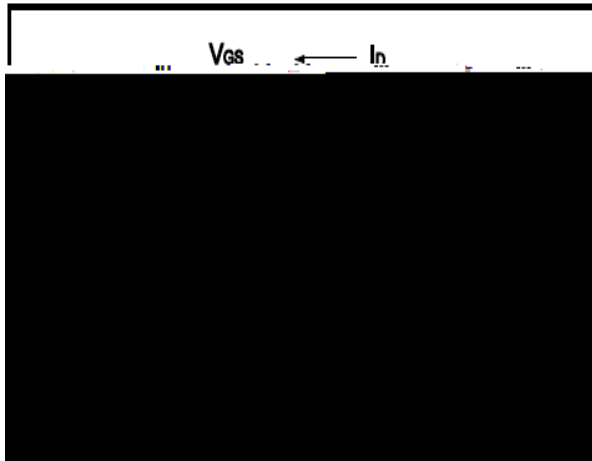

Fig.12 Gate Charge Waveform

