

General Description

The ZM140N10N combines advanced trench MOSFET technology with a low resistance package to provide extremely low $R_{DS(ON)}$.

Features

Trench technology
 $R_{DS(ON)}$ to minimize conductive loss

Application

Synchronous Rectification for AC-DC/DC-DC converter
 Oring switches

Product Summary

$V_{DS} = 100V$

$R_{DS(ON)} = 14m$

$I_D = 40A$

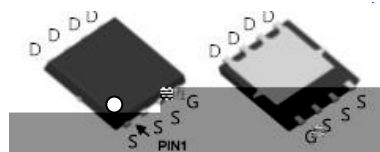

DFN56

Ordering Information:

Part NO.	ZM140N10N
Marking	ZM140N10
Packing Information	REEL TAPE
Basic ordering unit (pcs)	3000

Absolute Maximum Ratings $T_C = 25$

Parameter	Symbol	Rating	Unit
Drain-Source Voltage	V_{DS}	100	V
Gate-Source Voltage	V_{GS}	± 20	V
Continuous Drain Current	$I_{D@TC=25}$	40	A
	$I_{D@TC=75}$	30.4	A
	$I_{D@TC=100}$	25.2	A
Pulsed Drain Current	I_{DM}	105	A
Total Power Dissipation($T_C=25$)	$P_D@TC=25$	85	W
Total Power Dissipation($T_A=25$)	$P_D@TA=25$	3.4	W
Operating Junction Temperature	T_J	-55 to 150	
Storage Temperature	T_{STG}	-55 to 150	
Single Pulse Avalanche Energy@L=0.1mH	E_{AS}	80	mJ
Avalanche Current@L=0.1mH	I_{AS}	40	A

**Thermal resistance**

Parameter	Symbol	Min.	Typ.	Max.	Unit
Thermal resistance, junction - case	R_{thJC}	-	-	1.5	$^{\circ}C/W$
Thermal resistance, junction - ambient	R_{thJA}	-	-	37	$^{\circ}C/W$
Soldering temperature, wave soldering for 10s	T_{sold}	-	-	265	$^{\circ}C$

Electronic Characteristics

Parameter	Symbol	Condition	Min.	Typ	Max.	Unit
Drain-Source Breakdown Voltage	BV_{DSS}	$V_{GS}=0V, I_D=250\mu A$	100			V
Gate Threshold Voltage	$V_{GS(TH)}$	$V_{GS}=V_{DS}, I_D=250\mu A$	1.2		2.5	V
Drain-Source Leakage Current	I_{DSS}	$V_{DS}=100V, V_{GS}=0V$			1.0	μA
Gate- Source Leakage Current	I_{GSS}	$V_{GS}=\pm 20V, V_{DS}=0V$			± 100	nA
Static Drain-source On Resistance	$R_{DS(ON)}$	$V_{GS}=10V, I_D=20A$		14	17	m
		$V_{GS}=4.5V, I_D=12A$		17	20	m
Forward Transconductance	g_{FS}	$V_{DS}=25V, I_D=10A$		20		S
Source-drain voltage	V_{SD}	$I_S=20A$			1.28	V

Electronic Characteristics

Parameter	Symbol	Condition	Min.	Typ	Max.	Unit
Input capacitance	C_{iss}	$V_{GS}=0V, V_{DS}=25V$ $f = 1MHz$	-	4200	-	pF
Output capacitance	C_{oss}		-	184	-	
Reverse transfer capacitance	C_{rss}		-	150	-	

Gate Charge characteristics ($T_a=25^{\circ}C$)

Parameter	Symbol	Condition	Min.	Typ	Max.	Unit
Total gate charge	Q_g	$V_{DD} = 30V$ $I_D = 20A$ $V_{GS} = 10V$	-	74	-	nC
Gate - Source charge	Q_{gs}		-	20	-	
Gate - Drain charge	Q_{gd}		-	10	-	

Note:

;





Fig.7 On-Resistance VS Gate Source Voltage

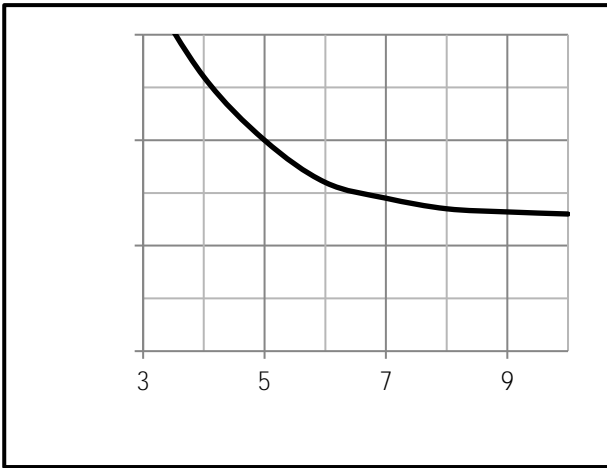

Fig.8 On-Resistance V.S Junction Temperature

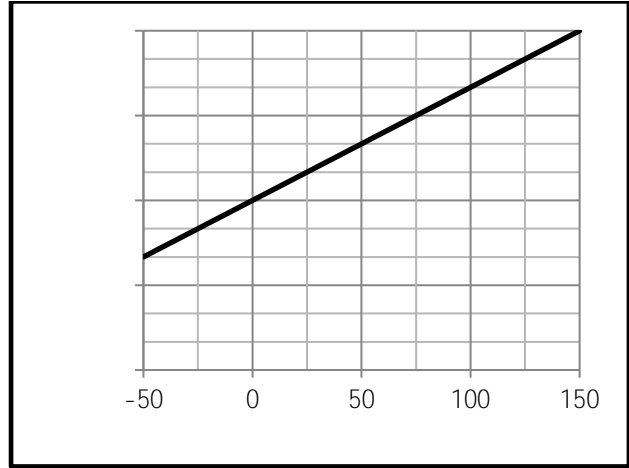

Fig.9 Switching Time Measurement Circuit

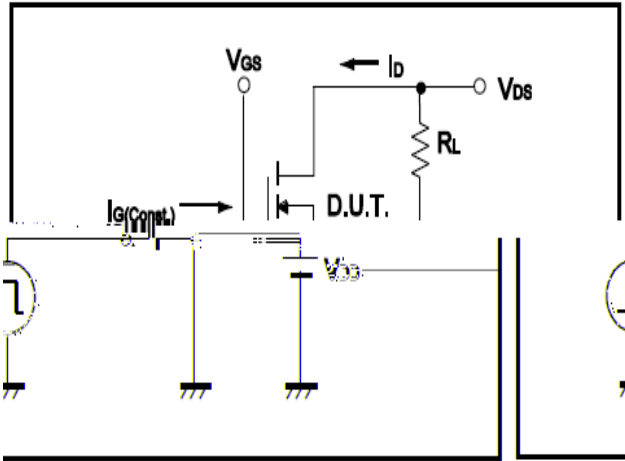

Fig.10 Gate Charge Waveform

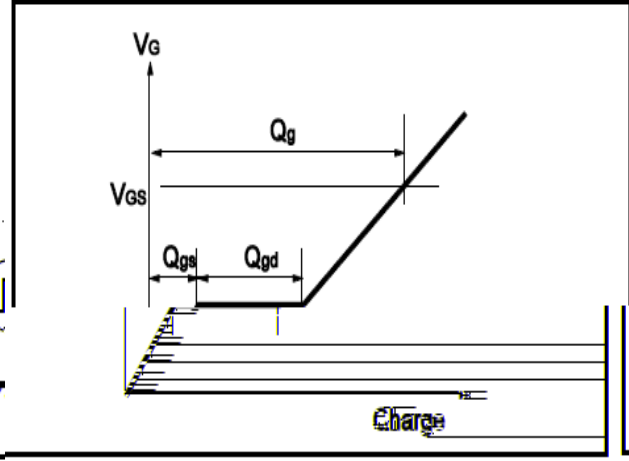

Fig.11 Switching Time Measurement Circuit

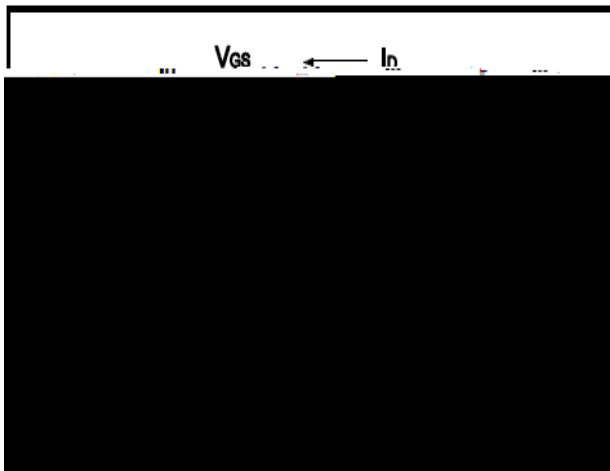
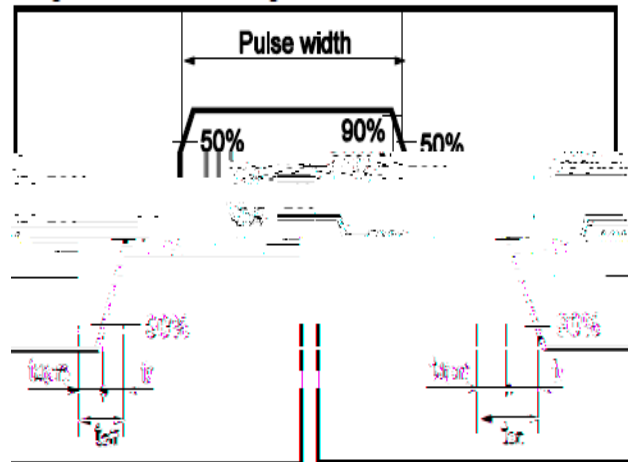

Fig.12 Gate Charge Waveform





Dimensions DFN5x6

Unit mm

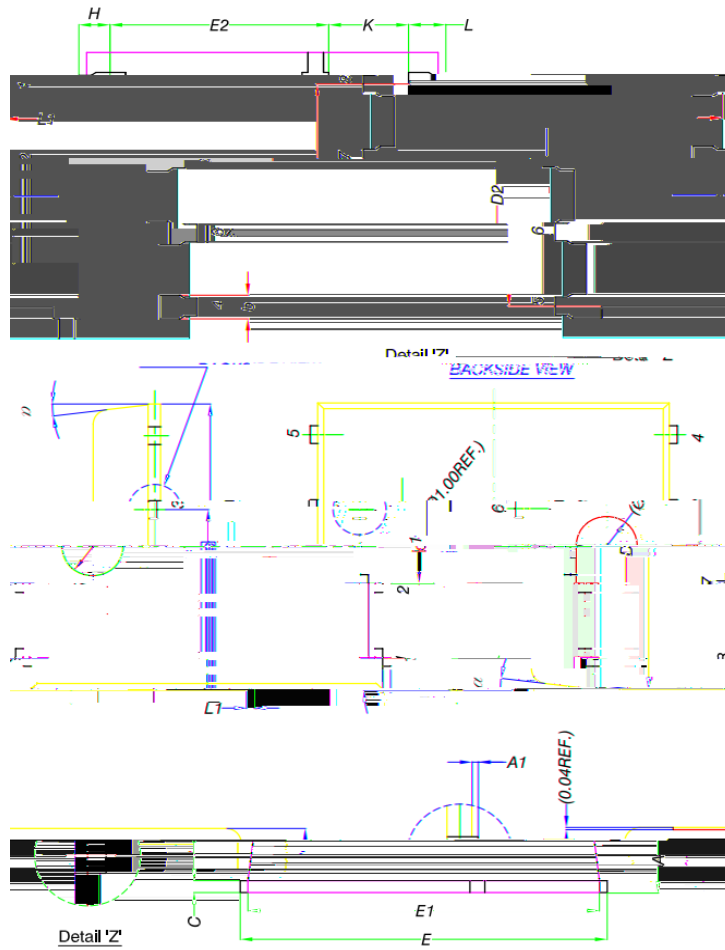

MILLIMETERS

D1	4.80	4.90	5.00
D2	3.67	3.81	3.96
	5.90	6.00	6.10
E1	5.78	5.78	5.78
e	1.27 BSC		
	0.41	0.51	0.61
	1.10		H
			K
	0.51	0.61	0.71
	0.51	0.61	0.71
	12°		