

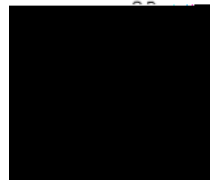

Product Summary

The ZM270P03U combines advanced trench MOSFET technology with a low resistance package to provide extremely low $R_{DS(ON)}$. This device is ideal for load switch and battery protection applications.



Advance high cell density Trench technology $R_{DS(ON)}$ to minimize conductive loss

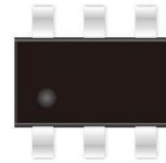

Load Switch
PWM Application

Part NO.	ZM270P03U
Marking	270P03
Packing Information	REEL TAPE
Basic ordering unit (pcs)	3000

$T_C = 25$

Parameter	Symbol	Rating	Unit
Drain-Source Voltage	V_{DS}	-30	V
Gate-Source Voltage	V_{GS}	± 20	V
Continuous Drain Current	$I_{D@TC=25^{\circ}C}$	-7	A
	$I_{D@TC=75^{\circ}C}$	-5.3	A
	$I_{D@TC=100^{\circ}C}$	-4.4	A
Pulsed Drain Current ④	I_{DM}	-25	A
Total Power Dissipation	P_D	12	W
Total Power Dissipation($T_A=25^{\circ}C$)	$P_{D@TA=25^{\circ}C}$	0.75	W
Operating Junction Temperature	T_J	-55 to 150	$^{\circ}C$
Storage Temperature	T_{STG}	-55 to 150	$^{\circ}C$

**Thermal resistance**

Parameter	Symbol	Min.	Typ.	Max.	Unit
Thermal resistance, junction - case	R_{thJC}	-	-	10	° C/W
Thermal resistance, junction - ambient	R_{thJA}	-	-	170	° C/W
Soldering temperature, wavesoldering for 10s	T_{sold}	-	-	265	° C

Parameter	Symbol	Condition	Min.	Typ	Max.	Unit
Drain-Source Breakdown Voltage	BV_{DSS}	$V_{GS}=0V, I_D=250\mu A$	-30			V
Gate Threshold Voltage	$V_{GS(TH)}$	$V_{GS}=V_{DS}, I_D=-250\mu A$	-1		-2.5	V
Drain-Source Leakage Current	I_{DSS}	$V_{DS}=-30V, V_{GS}=0V$			1.0	μA
Gate- Source Leakage Current	I_{GSS}	$V_{GS}=\pm 20V, V_{DS}=0V$			± 100	nA
Static Drain-source On Resistance		$V_{GS}=-10V, I_D=-7A$		27	34	m Ω
		$V_{GS}=-4.5V, I_D=-5A$		40	48	m Ω
Forward Transconductance	g_{FS}	$V_{DS}=-10V, I_D=-1A$		10		s



Fig.1 Power Dissipation Derating Curve

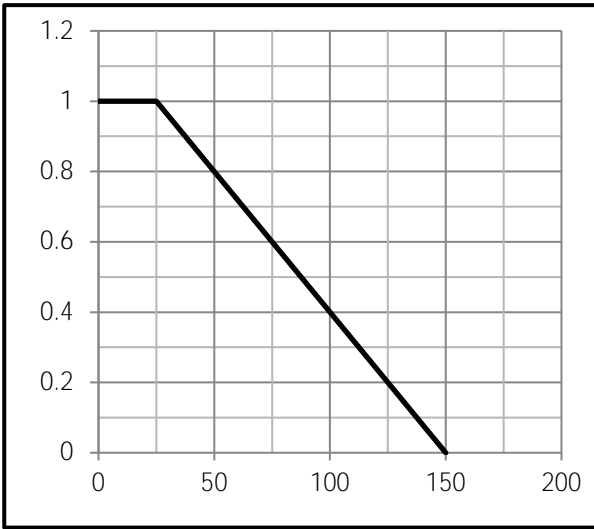

Fig.2 Typical output Characteristics

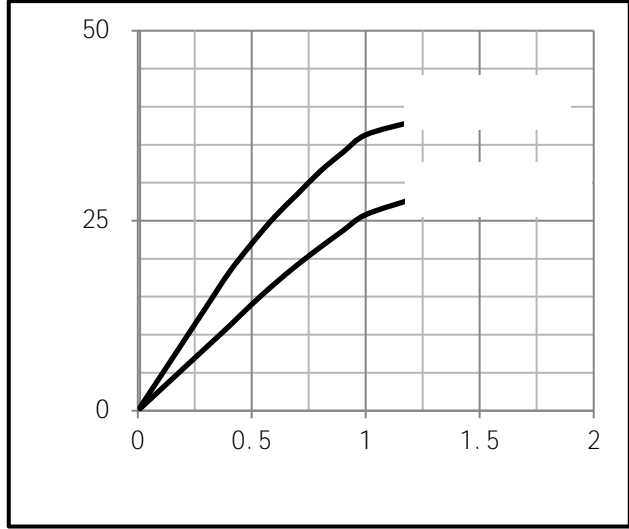

Fig.3 Threshold Voltage V.S Junction Temperature

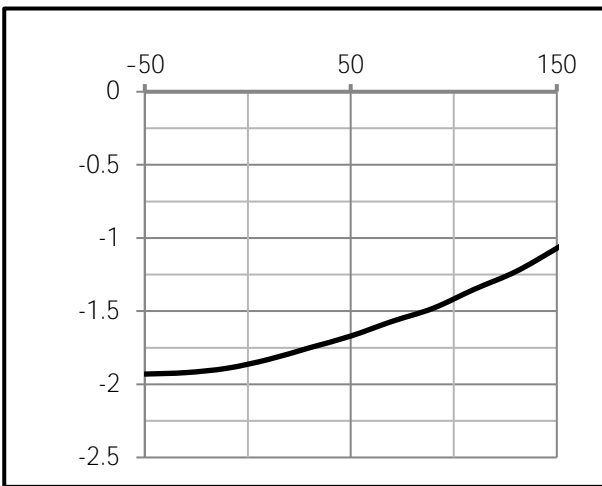
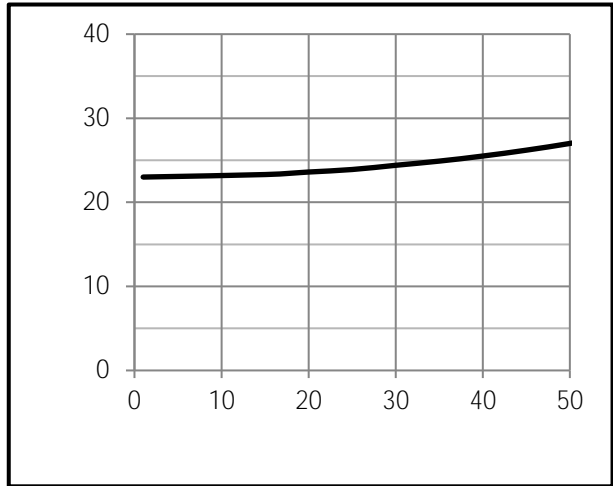

Fig.4 Resistance V.S Drain Current



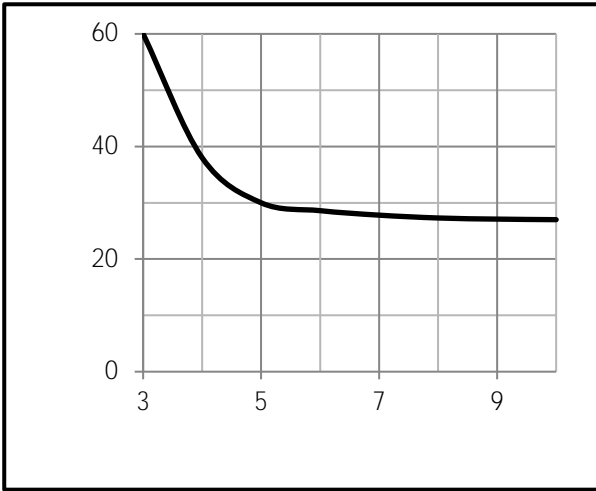

Fig.7 Switching Time Measurement Circuit

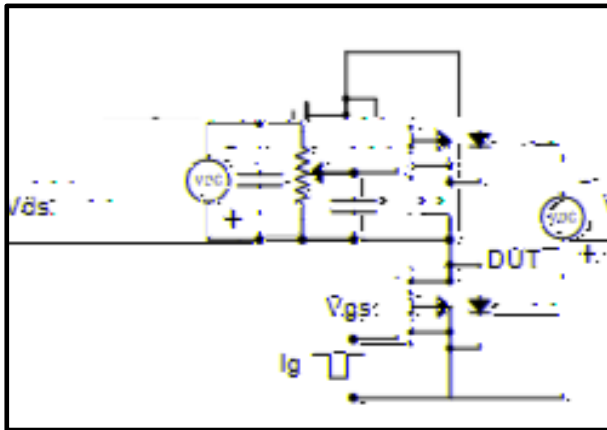

Fig.9 Switching Time Measurement Circuit

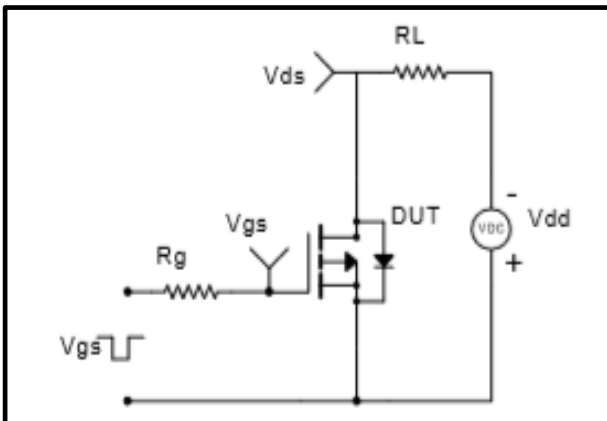

Fig.11 Avalanche Measurement Circuit

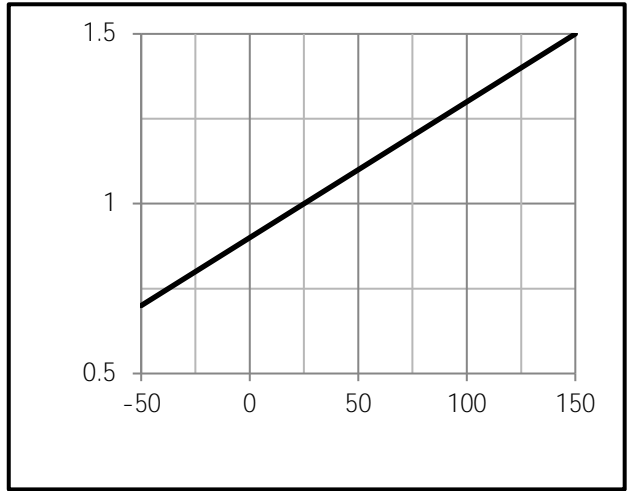
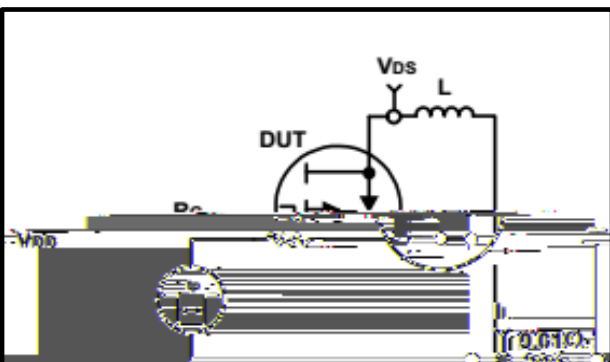

Fig.8 Gate Charge Waveform

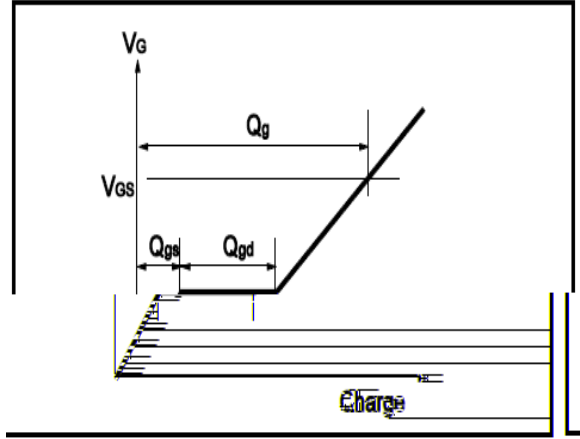

Fig.10 Gate Charge Waveform

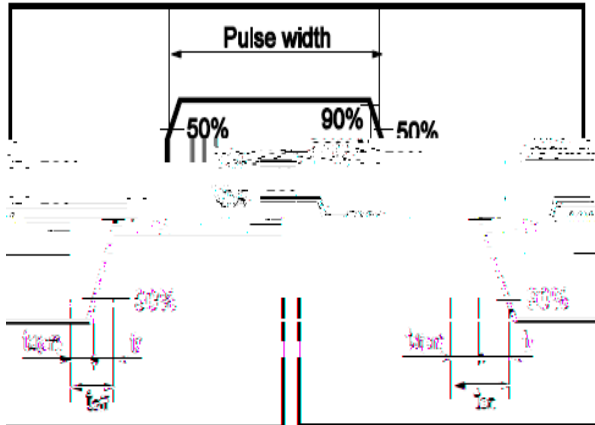
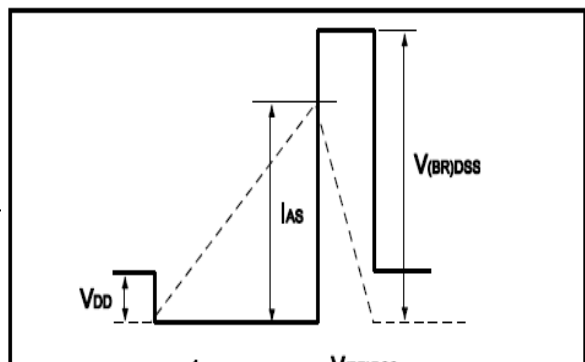

Fig.12 Avalanche Waveform





(SOT23-6)

Unit mm

