



**General Description**

The ZM280N06D combines advanced trench MOSFET technology with a low resistance package to provide extremely low  $R_{DS(ON)}$ . This device is ideal for load switch and battery protection applications.

**Features**

Trench technology  
 $R_{DS(ON)}$  to minimize conductive loss



**Ordering Information:**

**Absolute Maximum Ratings  $T_C = 25$**

Parameter	Symbol	Rating	Unit
Drain-Source Voltage	$V_{DS}$	60	V
Gate-Source Voltage	$V_{GS}$	$\pm 20$	V
Continuous Drain Current	$I_{D@TC=25}$	25	A
	$I_{D@TC=75}$	19	A
	$I_{D@TC=100}$	15.8	A
Pulsed Drain Current	$I_{DM}$	75	A
Total Power Dissipation( $TC=25$ )	$P_D@TC=25$	50	W
Total Power Dissipation( $TA=25$ )	$P_D@TA=25$	1.25	W
Operating Junction Temperature	$T_J$	-55 to 150	
Storage Temperature	$T_{STG}$	-55 to 150	
Single Pulse Avalanche Energy	$E_{AS}$	75	mJ



**Thermal resistance**

Parameter	Symbol	Min.	Typ.	Max.	Unit
Thermal resistance, junction - case	$R_{thJC}$	-	-	2.4	° C/W
Thermal resistance, junction - ambient	$R_{thJA}$	-	-	65	° C/W

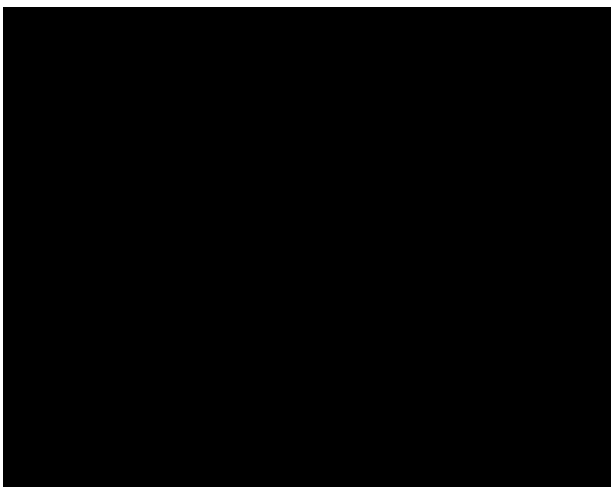
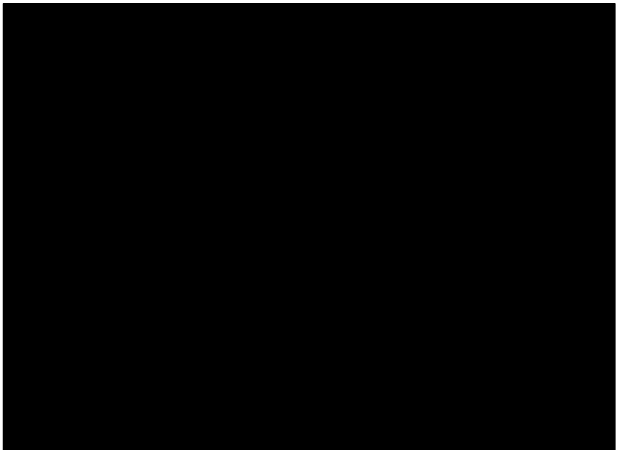
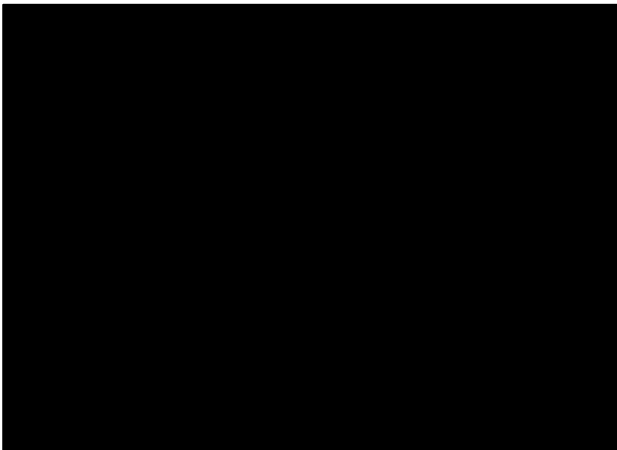
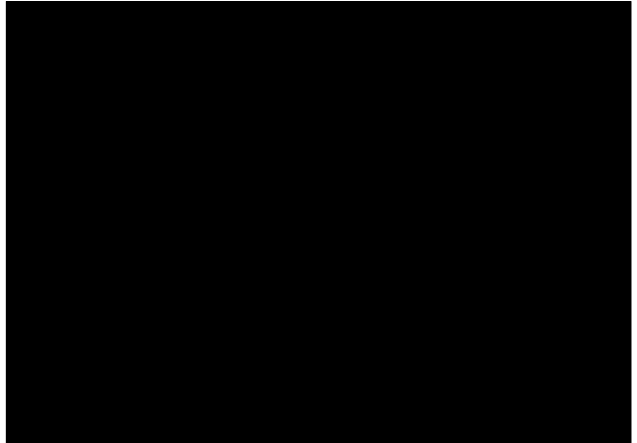
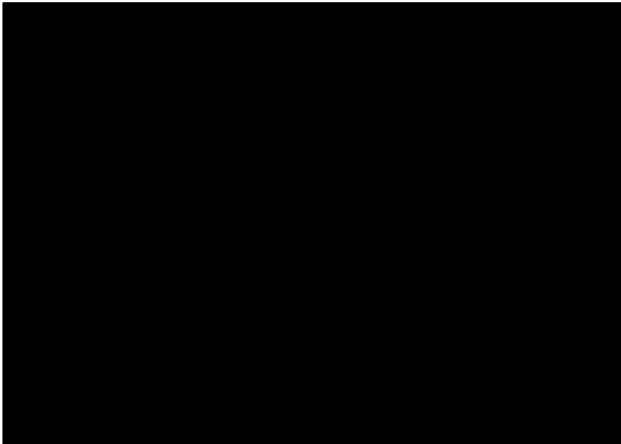

Fig.7 Switching Time Measurement Circuit

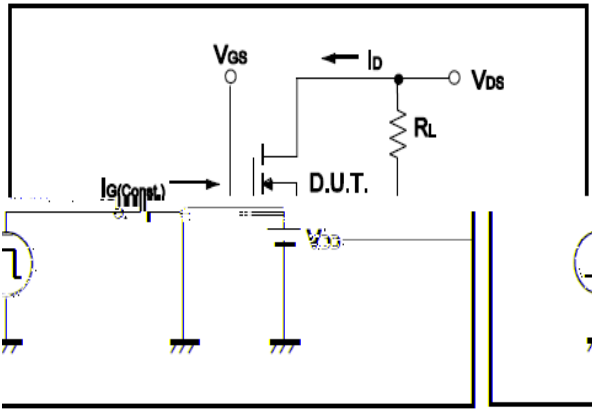

Fig.8 Gate Charge Waveform

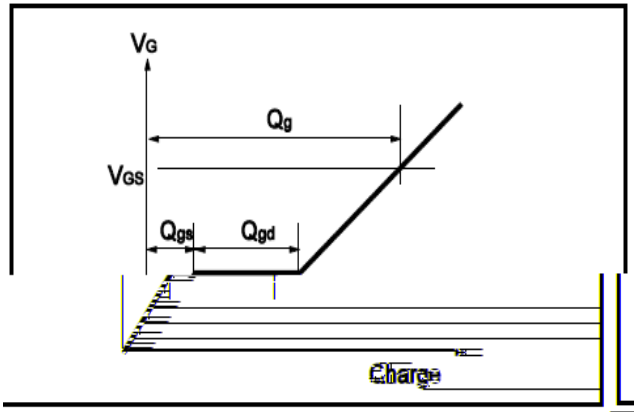

Fig.9 Switching Time Measurement Circuit

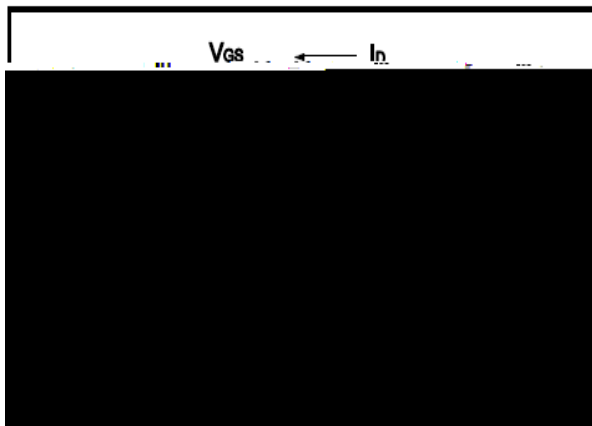

Fig.10 Gate Charge Waveform

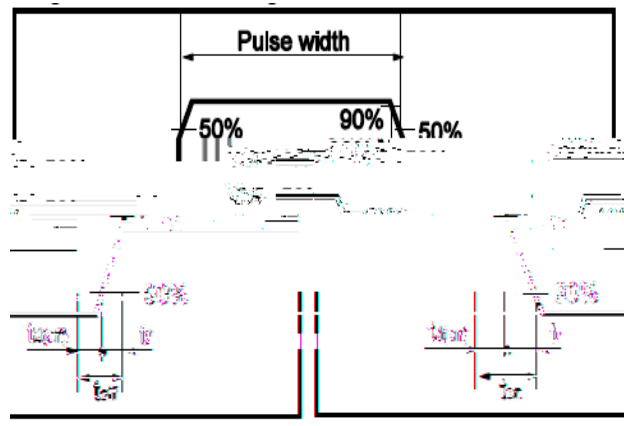

Fig.11 Avalanche Measurement Circuit

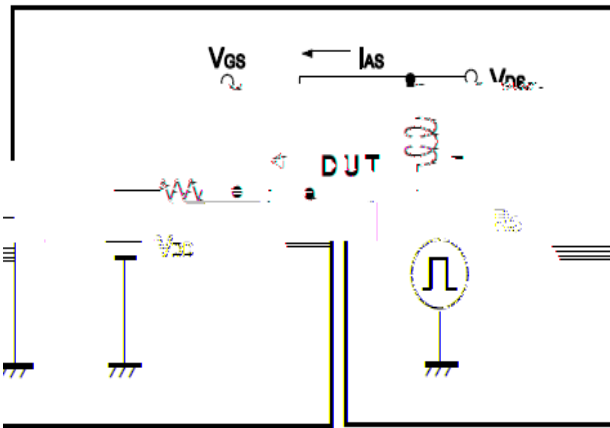
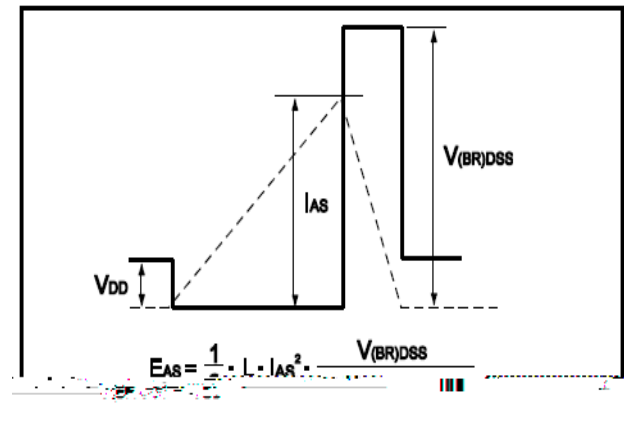

Fig.12 Avalanche Waveform





Dimensions(TO-252)

Unit mm

SYMBOL	mi n	max	SYMBOL	mi n	max
A	2.10	2.50	B	0.85	1.25
b	0.50	0.80	b1	0.50	0.90
b2	0.45	0.70	C	0.45	0.70
D	6.30	6.75	D1	5.10	5.50
E	5.30	6.30	e1	2.25	2.35
L1	9.20	10.60	e2	4.45	4.75
L2	0.90	1.75	L3	0.60	1.10
K	0.00	0.23			

