

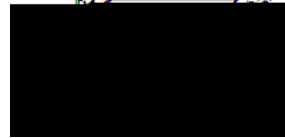

**Product Summary**

The ZMD68203TS combines advanced trench MOSFET technology with a low resistance package to provide extremely low  $R_{DS(ON)}$ . Two P Channel MOSFET inside for dual DIE implication.

$V_{DS1} = 20V$   
 $V_{DS2} = 20V$   
 $R_{DS(ON)1} = 8.5m$   
 $R_{DS(ON)2} = 8.5m$   
 $I_{D1} = 14A$   
 $I_{D2} = 14A$



density Trench technology  
 $R_{DS(ON)}$  to minimize conductive loss

Dual DIE in one package

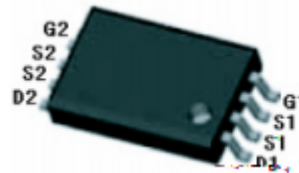

TSSOP-8

Power Management

Load Switch

Part NO.	ZMD68203TS
Marking	ZMD68203T
Packing Information	REEL TAPE
Basic ordering unit (pcs)	4000

**P Channel Absolute Maximum Ratings  $T_c = 25$**

Parameter	Symbol	Rating	Unit
Drain-Source Voltage	$V_{DS}$	20	V
Gate-Source Voltage	$V_{GS}$	$\pm 12$	V
Continuous Drain Current	$I_{D@TC=25}$	14	A
	$I_{D@TC=75}$	10.4	A
	$I_{D@TC=100}$	8.8	A
Pulsed Drain Current	$I_{DM}$	30	A
Total Power Dissipation( $TC=25$ )	$P_D@TC=25$	3.6	W
Total Power Dissipation( $TA=25$ )	$P_D@TA=25$	0.69	W
Operating Junction Temperature	$T_J$	-55 to 150	
Storage Temperature	$T_{STG}$	-55 to 150	
Single Pulse Avalanche Energy	$E_{AS}$	50	mJ

**Thermal resistance**

Parameter	Symbol	Min.	Typ.	Max.	Unit
Thermal resistance, junction - case	$R_{thJC}$	-	-	34	$^{\circ}C/W$
Thermal resistance, junction - ambient	$R_{thJA}$	-	-	180	$^{\circ}C/W$
Soldering temperature, wavesoldering for 10s	$T_{sold}$	-	-	265	$^{\circ}C$

**Electronic Characteristics**

Parameter	Symbol	Condition	Min.	Typ	Max.	Unit
Drain-Source Breakdown Voltage	$BV_{DSS}$	$V_{GS}=0V, I_D=250\mu A$	20			V
Gate Threshold Voltage	$V_{GS(TH)}$	$V_{GS}=V_{DS}, I_D=250\mu A$	0.3		1	V
Drain-Source Leakage Current	$I_{DSS}$	$V_{DS}=20V, V_{GS}=0V$			1.0	$\mu A$
Gate- Source Leakage Current	$I_{GSS}$	$V_{GS}=\pm 12V, V_{DS}=0V$			100	nA
Static Drain-source On Resistance	$R_{DS(ON)}$	$V_{GS}=4.5V, I_D=14A$				
		$V_{GS}=2.5V, I_D=10A$				
Forward Transconductance	$g_{FS}$	$V_{DS}=10V, I_D=10A$				
Source-drain voltage	$V_{SD}$	$I_S=14A$				

Parameter	Symbol	Condition	Min.	Typ	Max.	Unit
Input capacitance	$C_{iss}$	$f = 1MHz$	-	1050	-	pF
Output capacitance	$C_{oss}$		-	250	-	
Reverse transfer capacitance	$C_{rss}$		-	120	-	

**Gate Charge characteristics( $T_a = 25$  )**

Parameter	Symbol	Condition	Min.	Typ	Max.	Unit
Total gate charge	$Q_g$	$V_{DD}=25V$	-	12	-	nC
Gate - Source charge	$Q_{gs}$	$I_D=8A$	-	2	-	
Gate - Drain charge	$Q_{gd}$	$V_{GS}=10V$	-	5	-	



**P Channel characteristics curve**

Fig.1 Power Dissipation Derating Curve

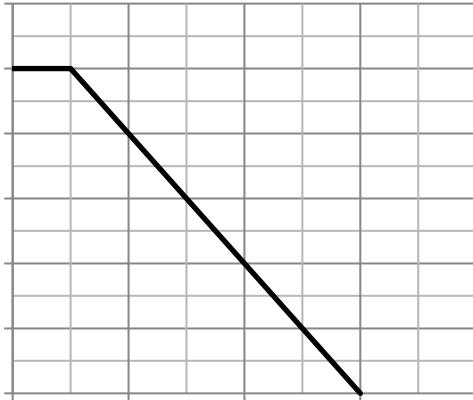

Fig.2 Typical output Characteristics

Fig.3 Threshold Voltage V.S Junction Temperature

Fig.4 Resistance V.S Drain Current

Fig.5 On-Resistance VS Gate Source Voltage

Fig.6 On-Resistance V.S Junction Temperature



Test Circuit

Fig.1 Switching Time Measurement Circuit

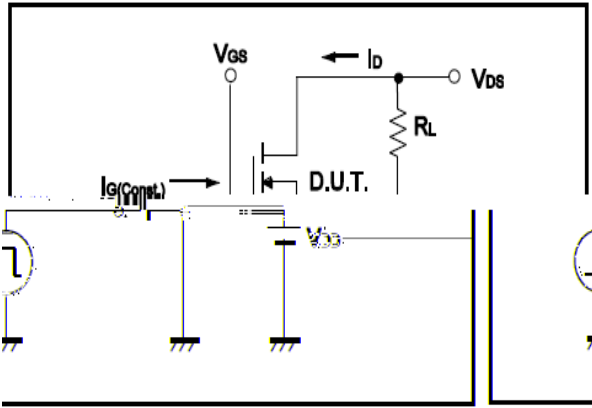

Fig.2 Gate Charge Waveform

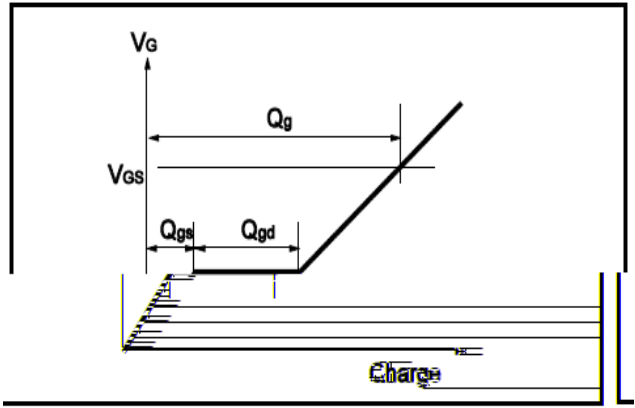

Fig.3 Switching Time Measurement Circuit

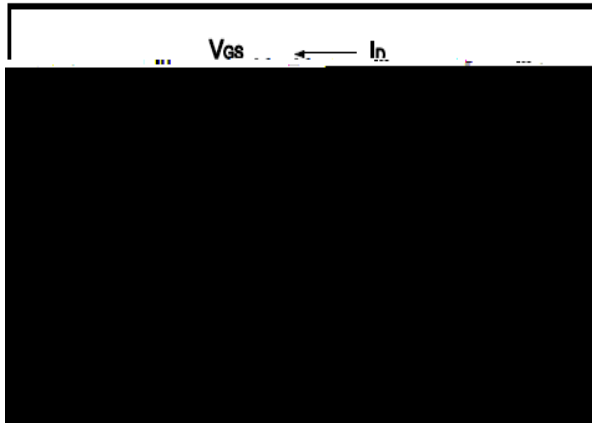

Fig.4 Gate Charge Waveform

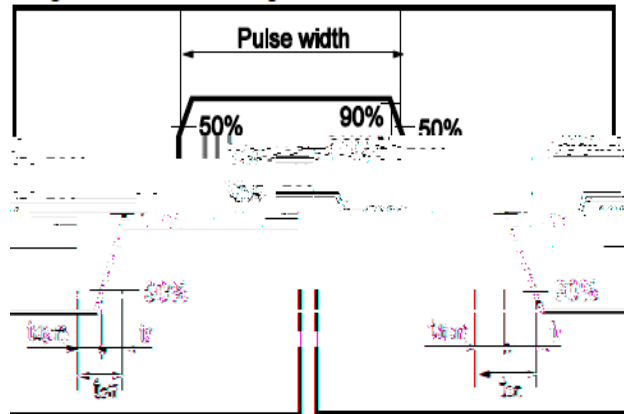

Fig.5 Avalanche Measurement Circuit

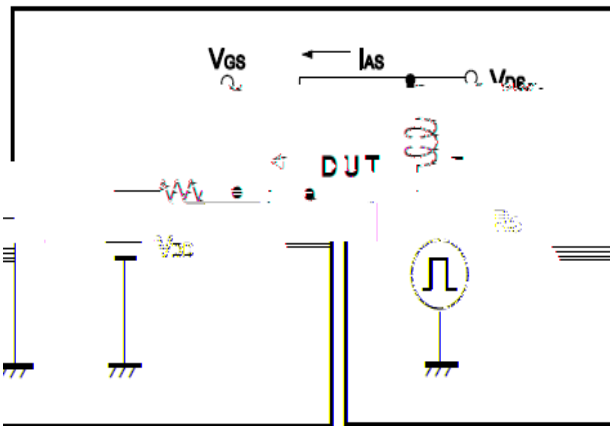
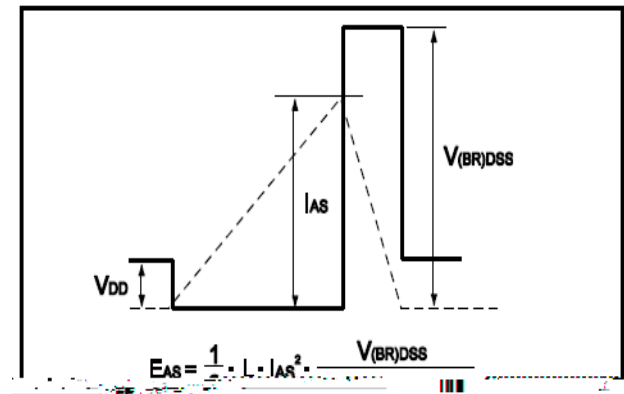

Fig.6 Avalanche Waveform





(TSSOP-8)

Unit: mm

Symbol	Dimensions In Millimeters	
	Min	Max
D	2.900	3.100
E	4.300	4.500
b	0.190	0.300
c	0.090	0.200
E1	6.250	6.550
A		1.100
A2	0.800	1.000
A1	0.020	0.150

