





Fig.1 Power Dissipation

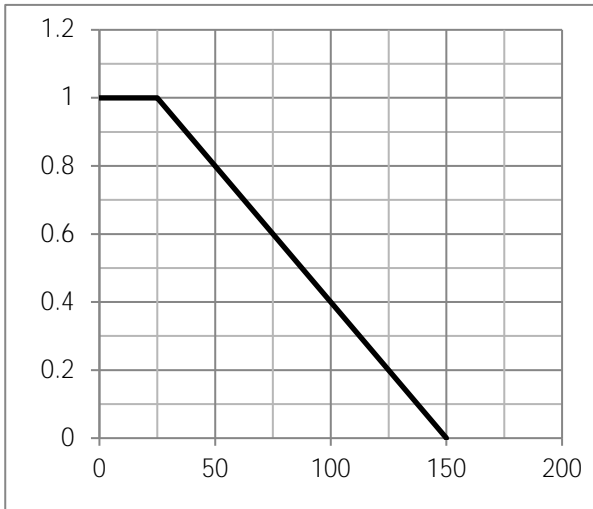

Fig.2 Typical output Characteristics

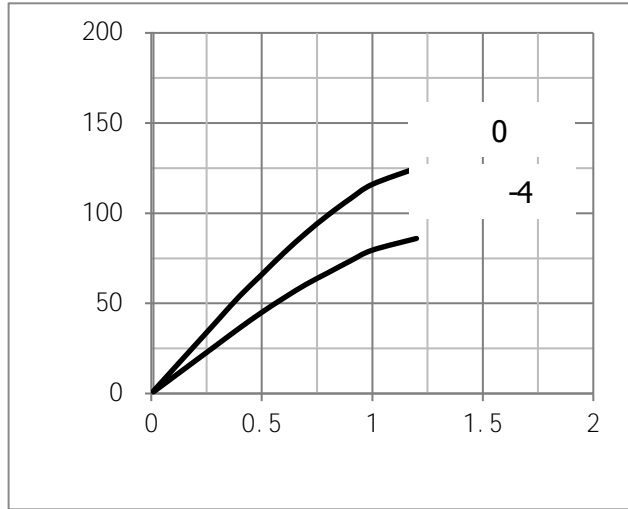

Fig.3 Threshold Voltage V.S Junction Temperature

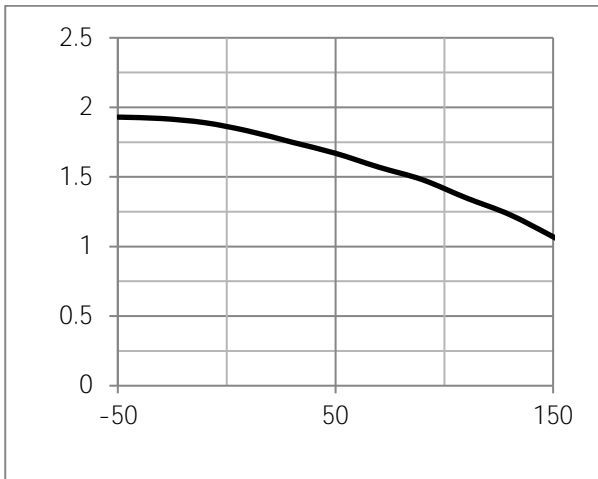
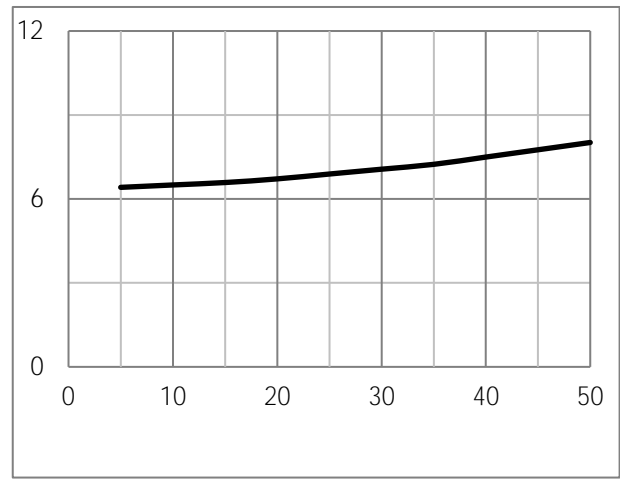
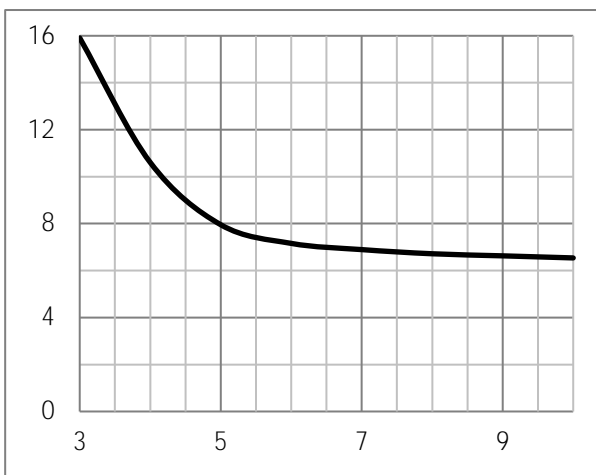

Fig.4 Resistance V.S Drain Current



4



5

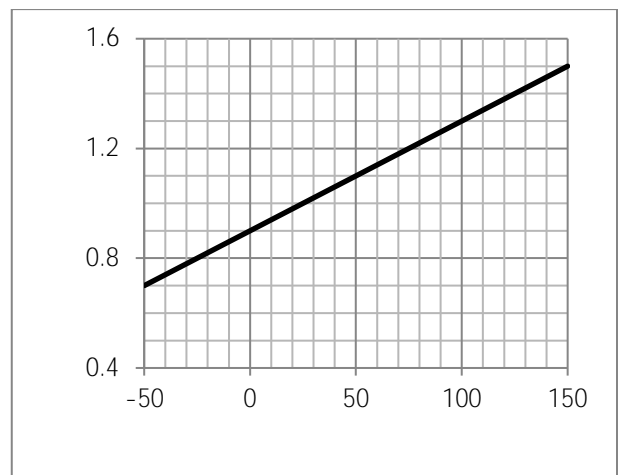

Fig.7 Switching Time Measurement Circuit

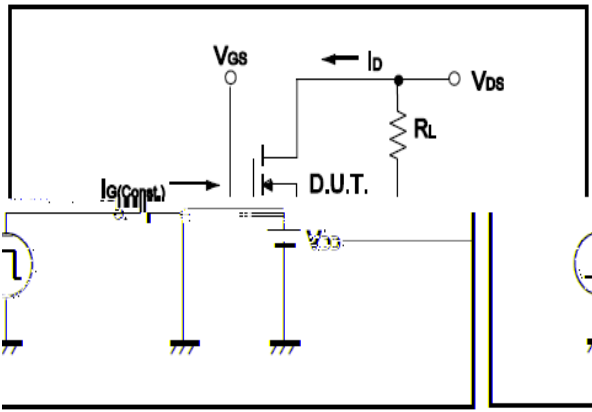

Fig.8 Gate Charge Waveform

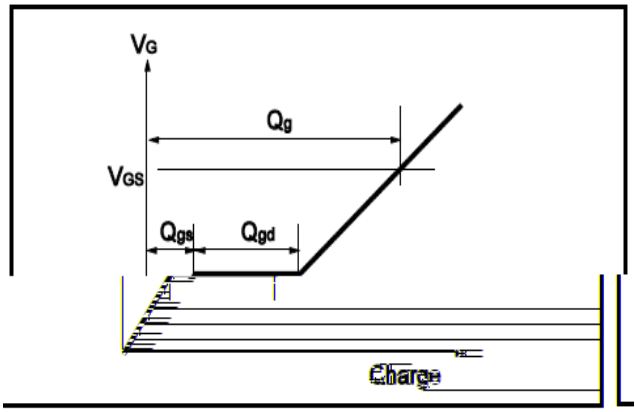

Fig.9 Switching Time Measurement Circuit

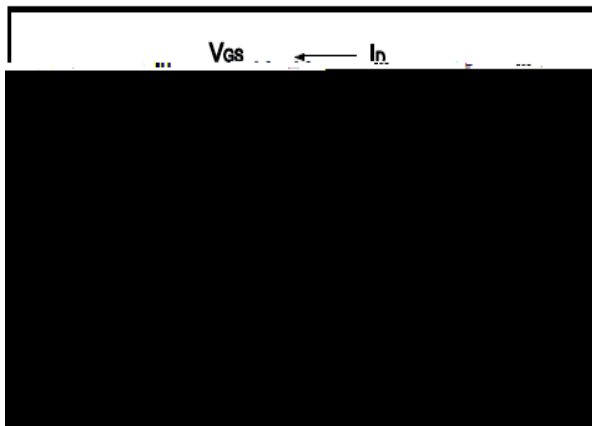

Fig.10 Gate Charge Waveform

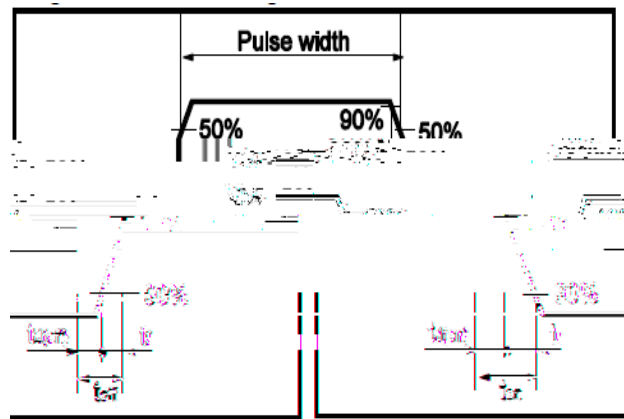

Fig.11 Avalanche Measurement Circuit

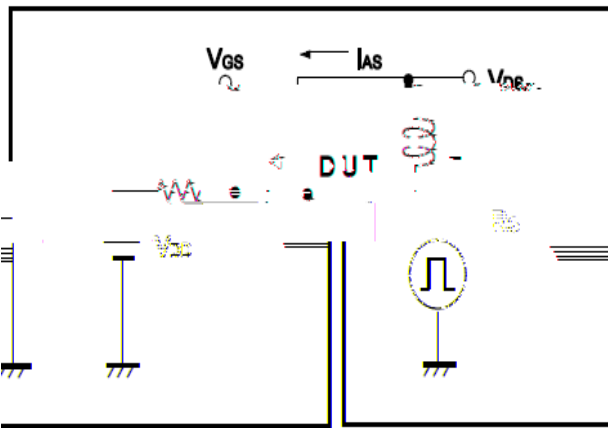
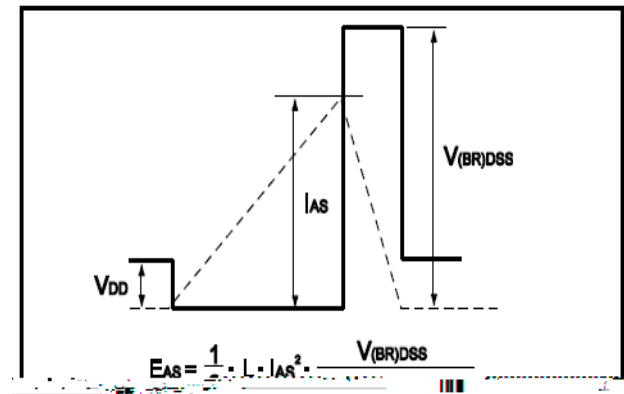

Fig.12 Avalanche Waveform





**Dimensions DFN5\*6**

Unit mm

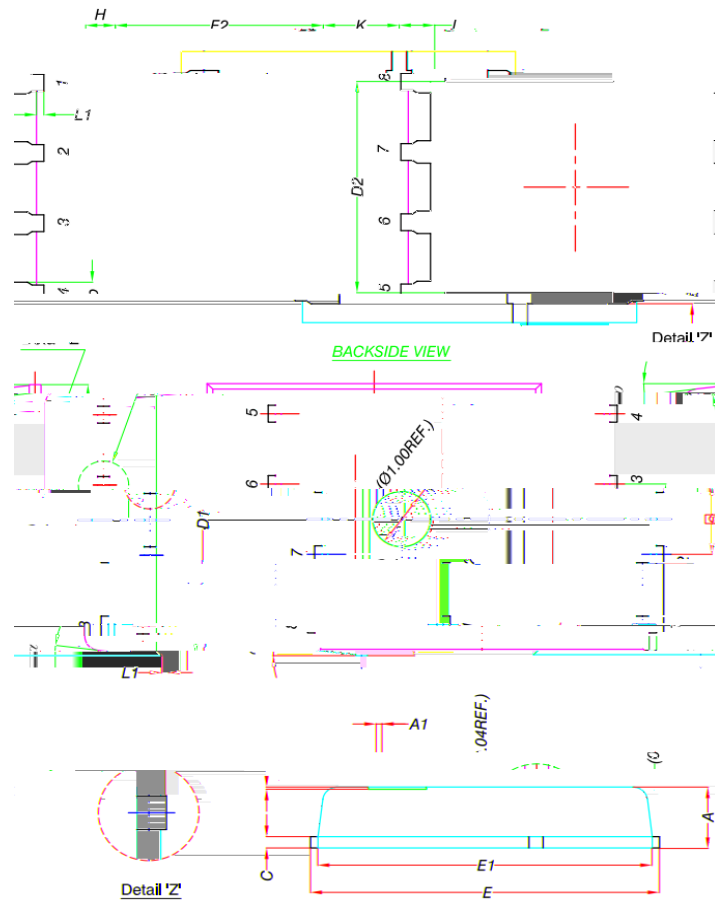

DIM.	MILLIMETERS		
	MIN.	NOM.	MAX.
A	0.90	1.00	1.40
A1	0	-	0.05
b	0.33	0.41	0.51
C	0.20	0.25	0.30
D1	4.80	4.90	5.00
D2	3.61	3.81	3.96

1	5.70	5.75	5.80	E
E2	3.30	3.58	3.78	
e	1.27 BSC			
H	0.45	0.51	0.61	
K	0.70	0.70	0.70	
L1	0.51	0.51	0.51	
L2	0.20	0.06	0.1	