



ZM060N06HP

60V N-Channel Power MOSFET

Fig.1 Gate-Charge Characteristics

Fig.2 Capacitance Characteristics

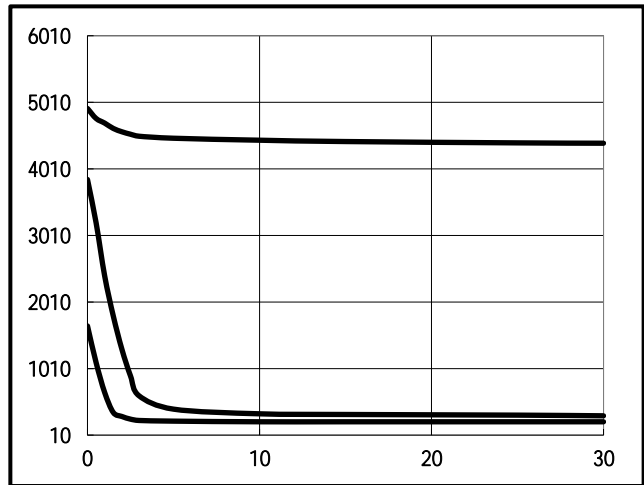

Fig.3 Power Dissipation

Fig.4 Typical output Characteristics

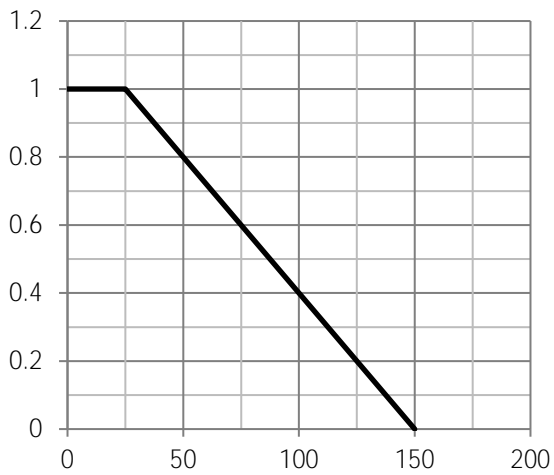

Fig.5 Threshold Voltage V.S Junction Temperature

Fig.6 Resistance V.S Drain Current

Fig.7 On-Resistance VS Gate Source Voltage

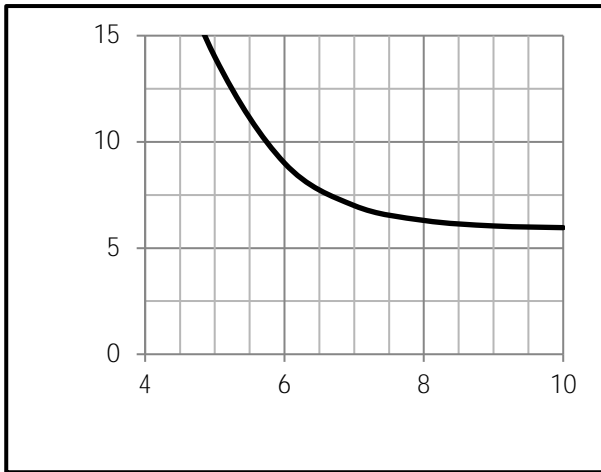

Fig.8 On-Resistance V.S Junction Temperature

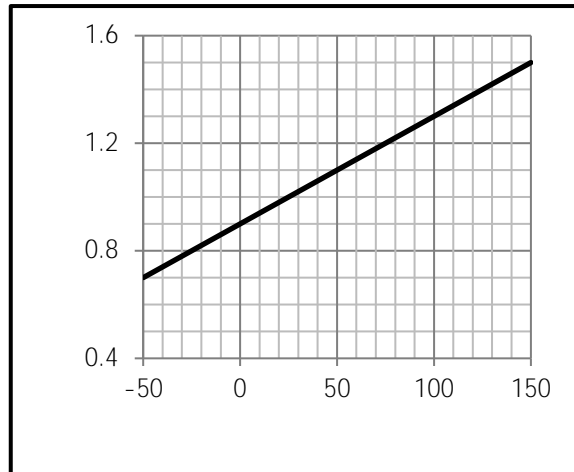

Fig.9 Switching Time Measurement Circuit

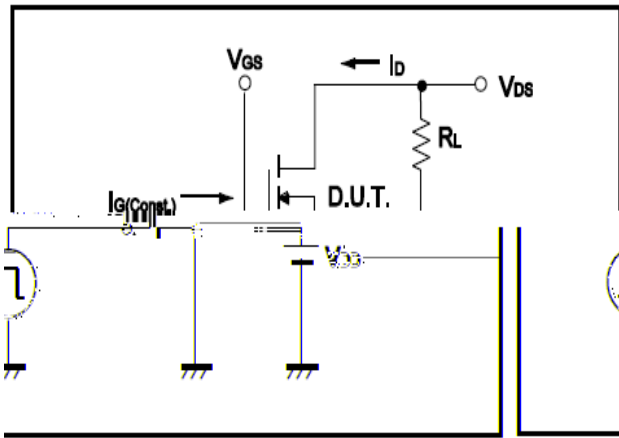

Fig.10 Gate Charge Waveform

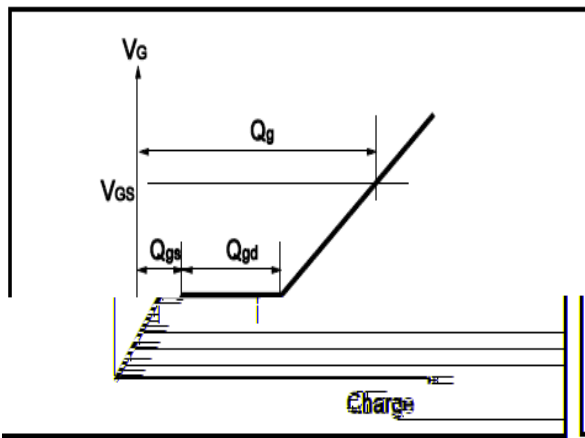

Fig.11 Switching Time Measurement Circuit

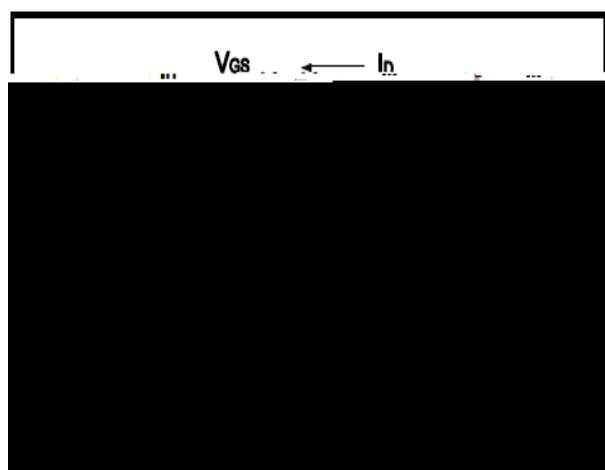

Fig.12 Gate Charge Waveform

