

General Description

The ZMD68403S combines advanced trench MOSFET technology with a low resistance package to provide extremely low $R_{DS(ON)}$. This device is ideal for load switch and battery protection applications.

Features

Advance high cell density Trench technology

g $B_{DS(ON)}$ to minimize conductive loss

g 7 QU 3 XQWU V bV Cdcg YSYW

Dual DIE in one package

Product Summary

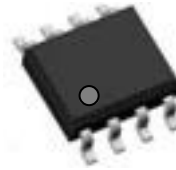
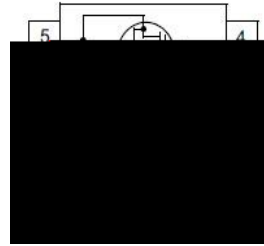

Application

Power Management in Notebook Computer,
 Portable Equipment and Battery Powered
 Systems

4

Ordering Information:

	ZMD68403S
	ZMD68403
	REEL TAPE
	4000

4

Absolute Maximum Ratings $T_C = 25$

Parameter	Symbol	Rating	Unit
Drain-Source Voltage	V_{DS}	40	V
Gate-Source Voltage	V_{GS}	± 20	V
Continuous Drain Current	$I_D@T_C=25$	10	A
	$I_D@T_C=75$	7.6	A
	$I_D@T_C=100$	6.3	A
Pulsed Drain Current	I_{DM}	30	A
Total Power Dissipation	$P_D@T_C=25$	3.6	W
Total Power Dissipation	$P_D@T_A=25$	0.69	W
Operating Junction Temperature	T_J	-55 to 175	
Storage Temperature	T_{STG}	-55 to 175	
Single Pulse Avalanche Energy ($L=0.5mH, V_{GS}=10V, R_g=25 \Omega, D_J=25\%$)	E_{AS}	85	mJ

Single Pulse Avalanche Energy ($L=0.1\text{mH}, V_{GS}=10\text{V}, R_g=25 \text{ } D_J=25 \text{ })$	E_{AS}	34	mJ
---	----------	----	----

Thermal resistance

Parameter	Symbol	Min.	Typ.	Max.	Unit
Thermal resistance, junction - case	R_{thJC}	-	-	2.5	$^{\circ}\text{C/W}$
Thermal resistance, junction - ambient	R_{thJA}	-	-	70	$^{\circ}\text{C/W}$
Soldering temperature, wavesoldering for 10s	T_{sold}	-	-	265	$^{\circ}\text{C}$

4

Electronic Characteristics

Parameter	Symbol	Condition	Min.	Typ	Max.	Unit
Drain-Source Breakdown Voltage	BV_{DSS}	$V_{GS}=0\text{V}, I_D=250\mu\text{A}$	40			V
Gate Threshold Voltage	$V_{GS(TH)}$	$V_{GS}=V_{DS}, I_D=250\mu\text{A}$	1.2		2.5	V
Drain-Source Leakage Current	I_{DSS}	$V_{DS}=40\text{V}, V_{GS}=0\text{V}$			1.0	μA
Gate- Source Leakage Current	I_{GSS}	$V_{GS}=\pm 20\text{V}, V_{DS}=0\text{V}$			100	nA
Static Drain-source On Resistance		$V_{GS}=10\text{V}, I_D=10\text{A}$				
		$V_{GS}=4.5\text{V}, I_D=8\text{A}$				
Forward Transconductance	g_{FS}	$V_{DS}=25\text{V}, I_D=4\text{A}$				

4

Dynamic Characteristics

Parameter	Symbol	Condition	Min.	Typ	Max.	Unit
Input capaciG(l) -0.0148 reW*r						



Diode Characteristics

Parameter	Symbol	Condition	Min.	Typ	Max.	Unit
				8		ns

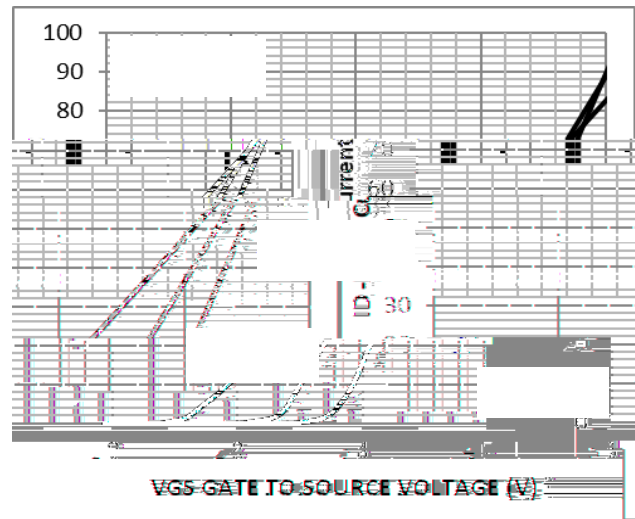
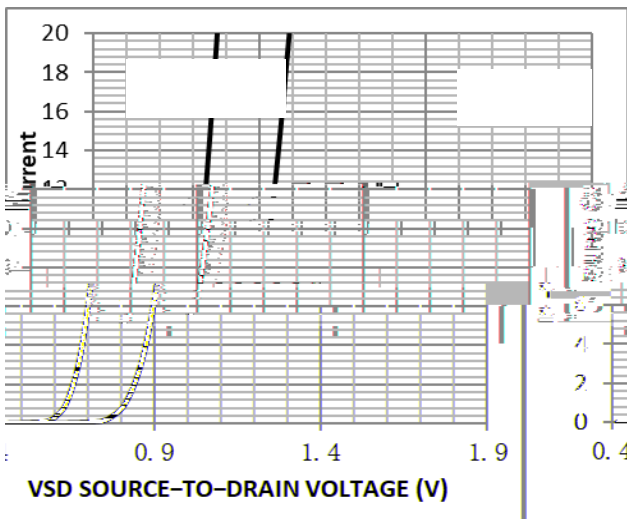
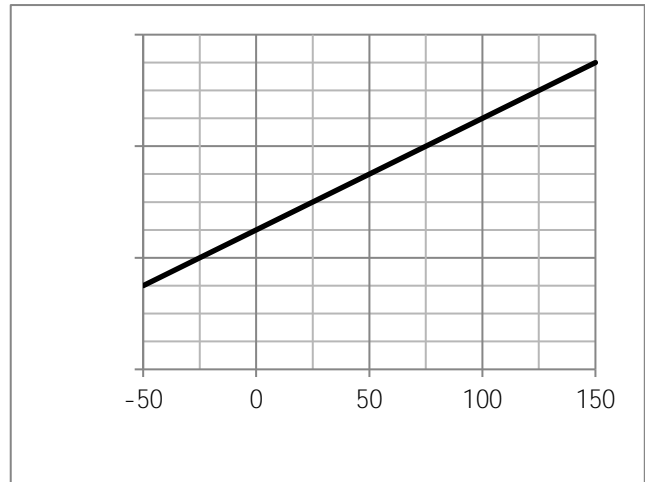
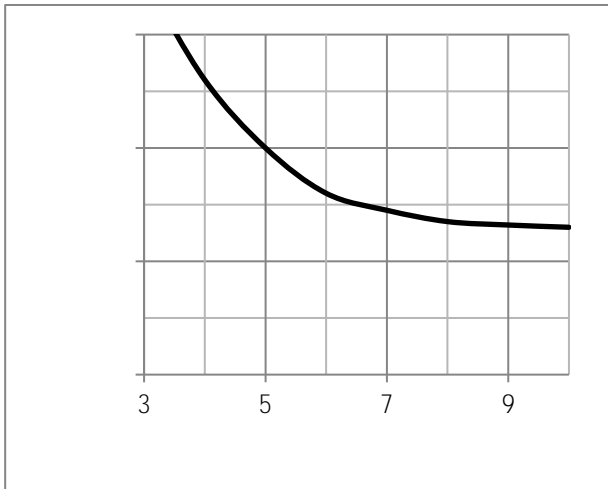

Fig.9 SOA Maximum Safe Operating Area

Fig.10 ID-Junction Temperature

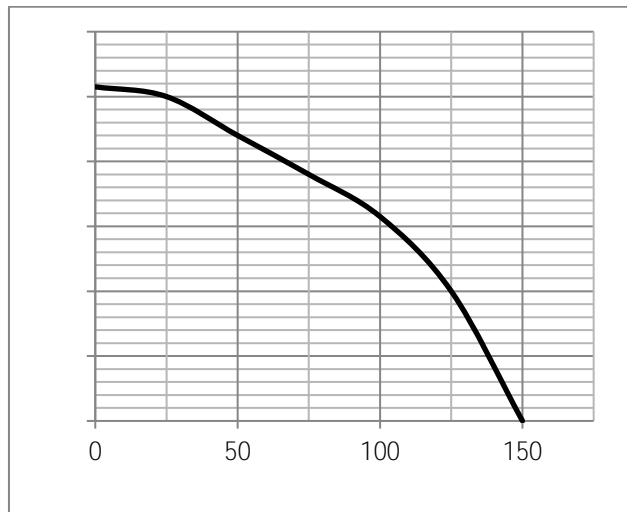
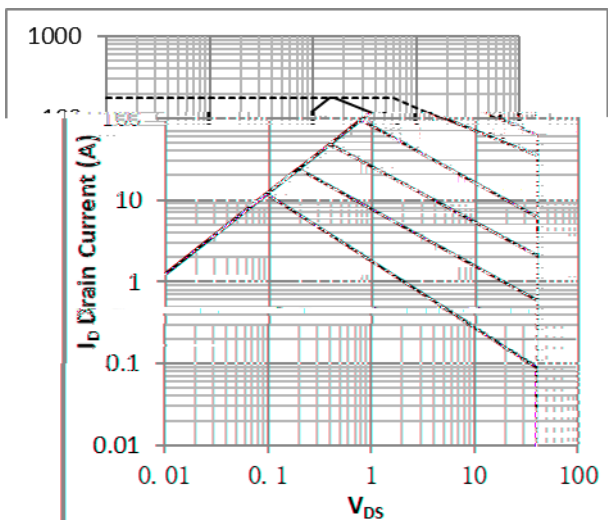

Fig.12

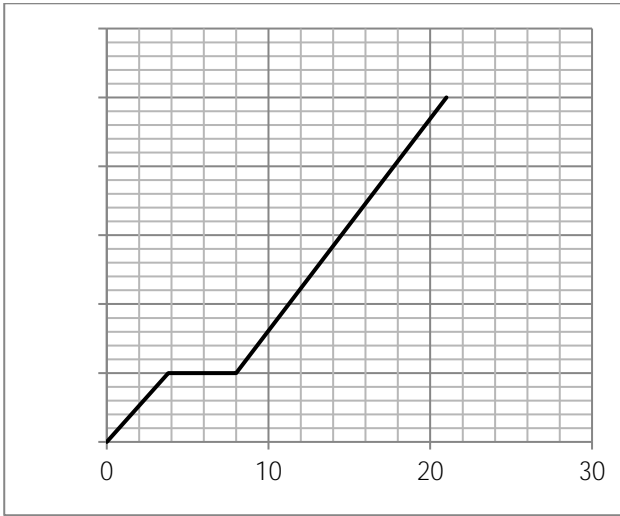

Fig.13 Switching Time Measurement Circuit

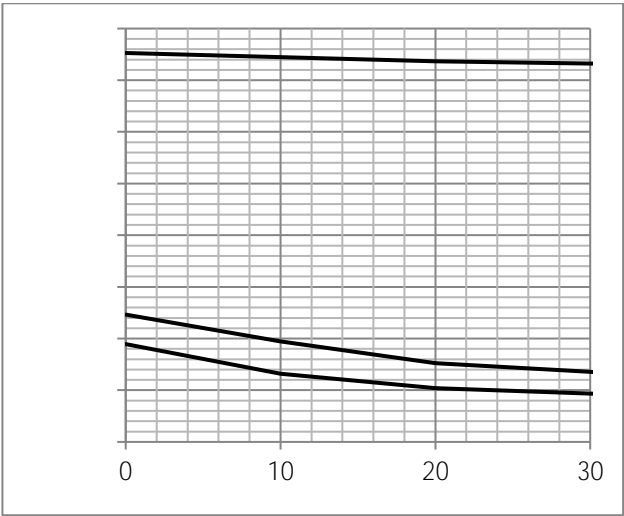
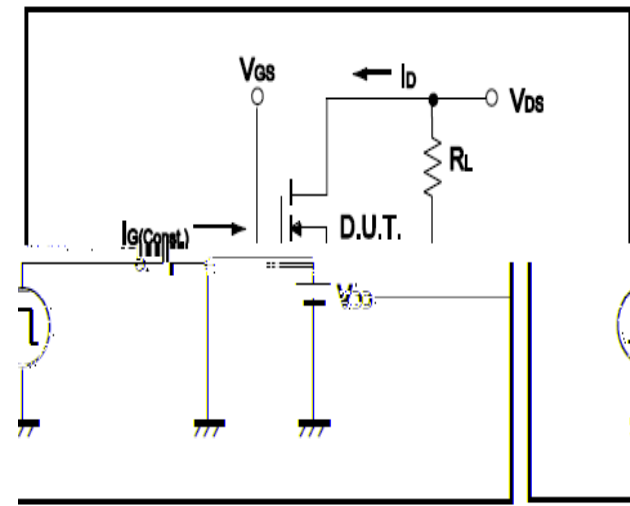

Fig.14 Gate Charge Waveform

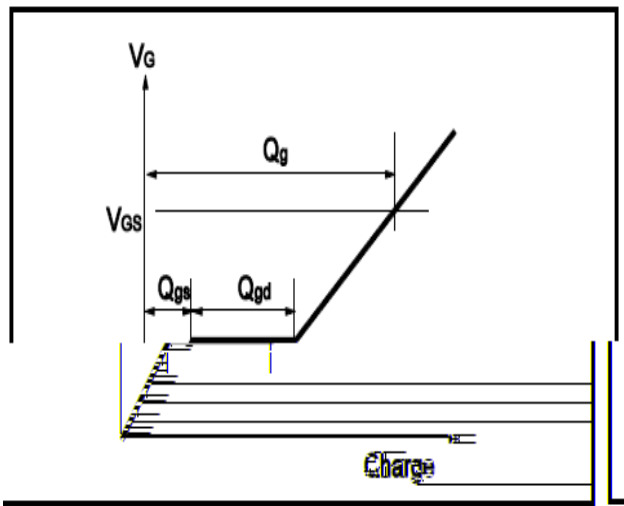

Fig.15 Switching Time Measurement Circuit

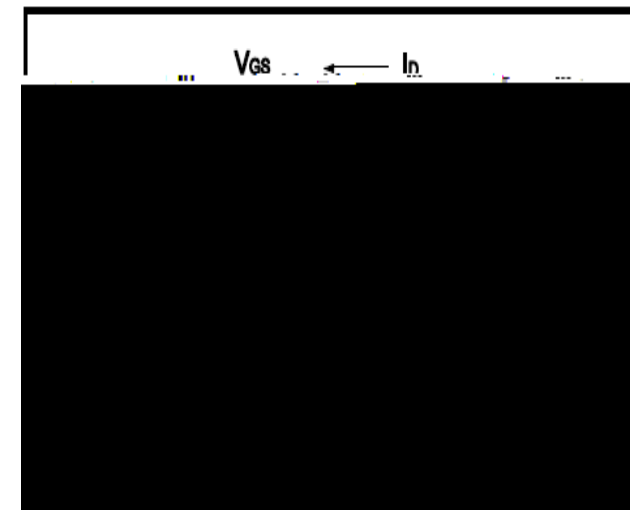

Fig.16 Gate Charge Waveform

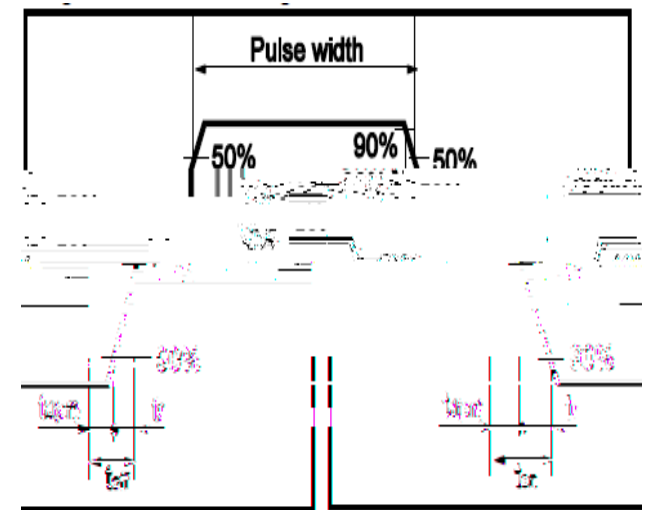

Fig.17 Avalanche Measurement Circuit

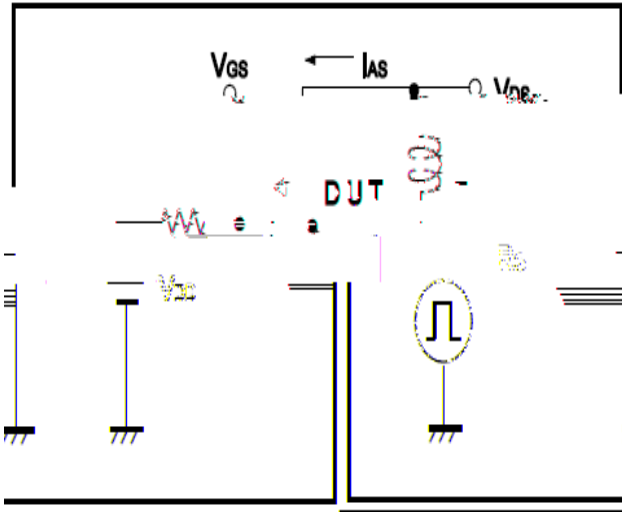
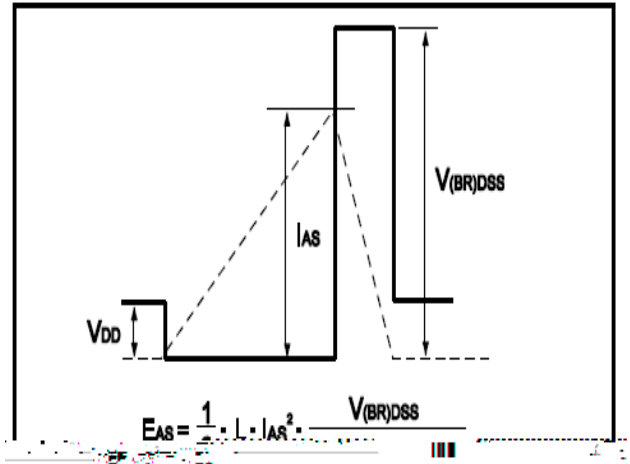

Fig.18 Avalanche Waveform



Dimensions(SOP8)

Unit: mm

SYMBOL	min	TYP	max	SYMBOL	min		max
A	4.80		5.25	C	1.30		1.75
A1	0.37		0.49	C1	0.55		0.75
A2		1.27		C2	0.55		0.65
A3		0.41		C3	0.05		0.20
B	5.80		6.20	C4	0.10	0.20	0.23
B1	3.80		4.10	D		1.05	
B2		5.00		D1	0.40		0.62

