

Input capacitance	Ciss	f = 1MHz V _{DS} =25V	-	280	-	pF
Output capacitance	Coss		-	46	-	
Reverse transfer capacitance	Crss		-	25	-	
Total gate charge	Qg	V _{DD} = 25V I _D = 5A V _{GS} = 10V	-	5.3	-	nC
Gate - Source charge	Qgs		-	1.4	-	
Gate - Drain charge	Qgd		-	0.8	-	

P Channel Electronic Characteristics

Parameter	Symbol	Condition	Min.	Typ	Max.	Unit
Drain-Source Breakdown Voltage	BV _{DSS}	V _{GS} = 0V, I _D = -250uA	-30			V
Gate Threshold Voltage	V _{GS(TH)}	V _{GS} = V _{DS} , I _D = -250uA	-1.2		-2.5	V
Drain-Source Leakage Current	I _{DSS}	V _{DS} = -30V, V _{GS} = 0V			-1.0	uA
Gate- Source Leakage Current	I _{GSS}	V _{GS} = ±20V, V _{DS} = 0V			100	nA
Static Drain-source On Resistance		V _{GS} = -10V, I _D = -6A				
		V _{GS} = -4.5V, I _D = -4A				
Forward Transconductance	g _{FS}	V _{DS} = -10V, I _D = -5A				

Dynamic Characteristics

Parameter	Symbol	Condition	Min.	Typ	Max.	Unit
Gate Resistance	Rg	f = 1MHz		10		
Input capacitance	Ciss	f = 1MHz V _{DS} =25V	-	850	-	pF
Output capacitance	Coss		-	125	-	
Reverse transfer capacitance	Crss		-	115	-	
Total gate charge	Qg	V _{DD} = 25V I _D = 5A V _{GS} = 10V	-	12	-	nC
Gate - Source charge	Qgs		-	5	-	
Gate - Drain charge	Qgd		-	6	-	

P Channel characteristics curve

Fig.1 Power Dissipation Derating Curve

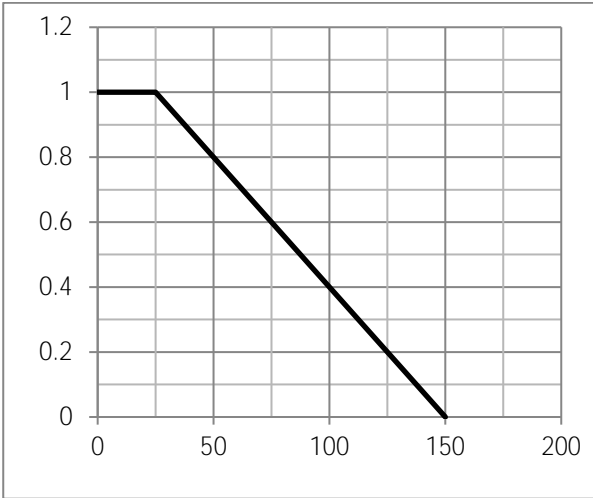

Fig.2 Typical output Characteristics

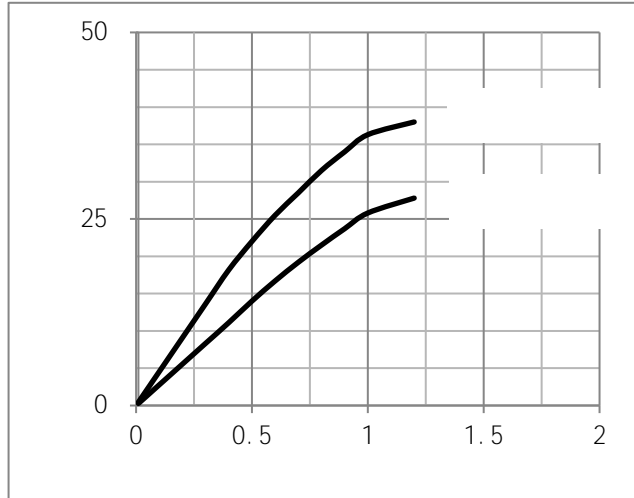

Fig.3 Threshold Voltage V.S Junction Temperature

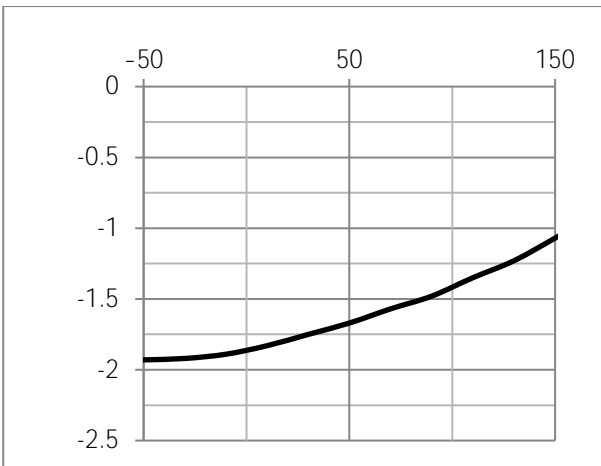
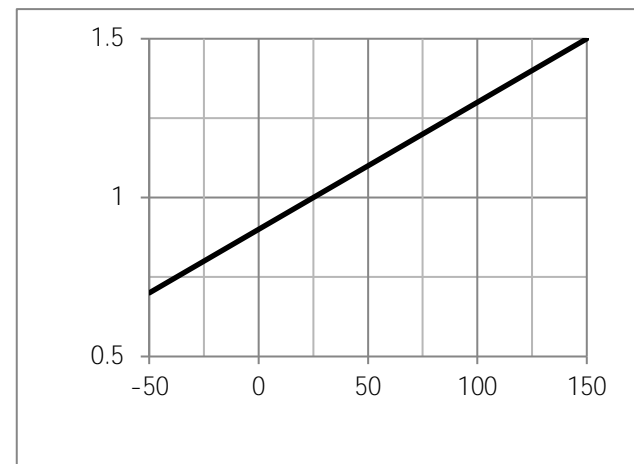
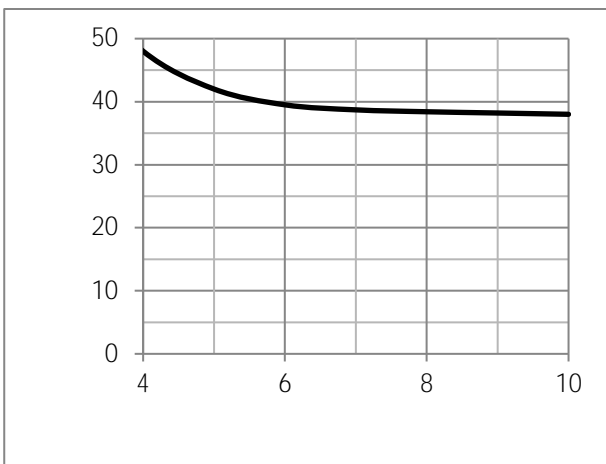
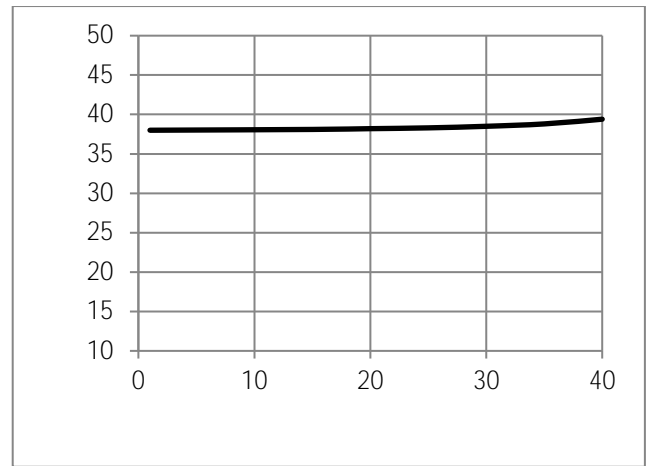

Fig.4 Resistance V.S Drain Current



Test Circuit

Fig.1 Switching Time Measurement Circuit

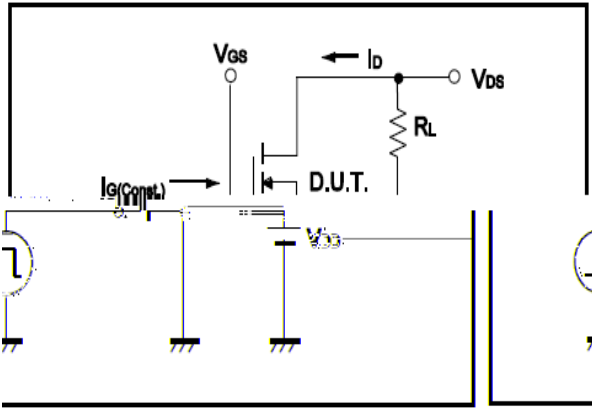

Fig.2 Gate Charge Waveform

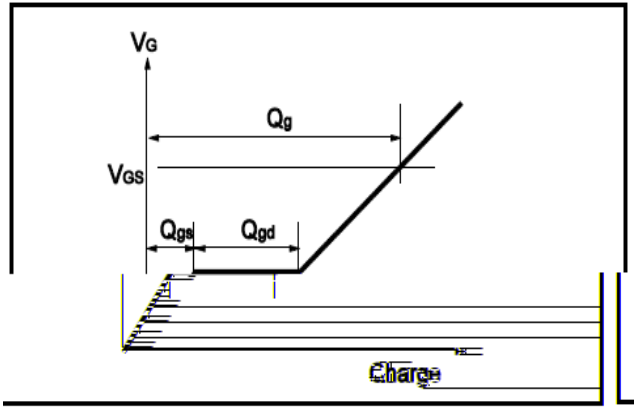

Fig.3 Switching Time Measurement Circuit

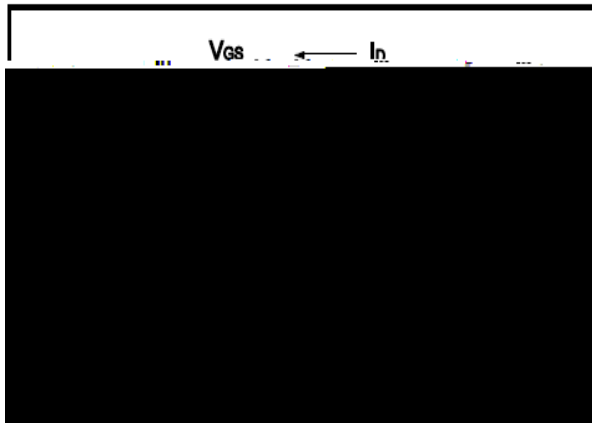

Fig.4 Gate Charge Waveform

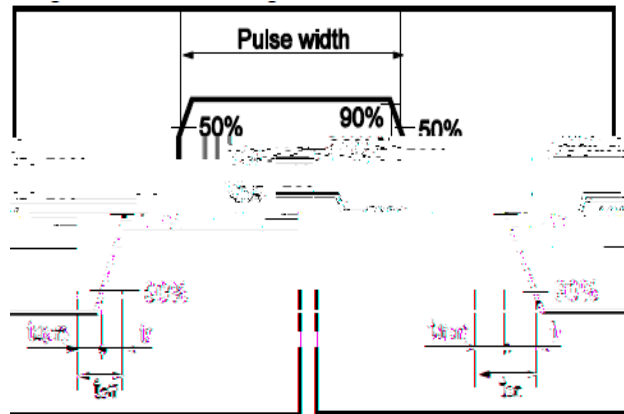

Fig.5 Avalanche Measurement Circuit

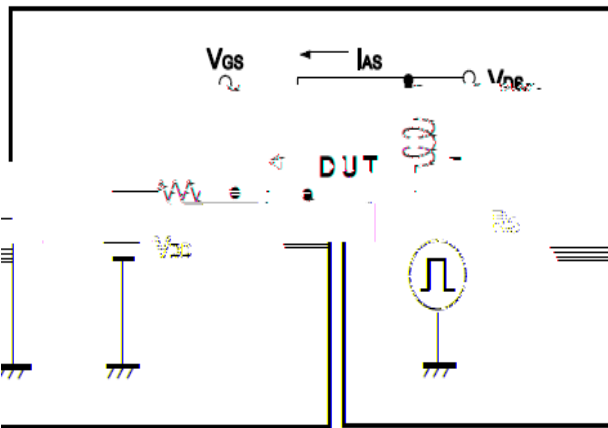
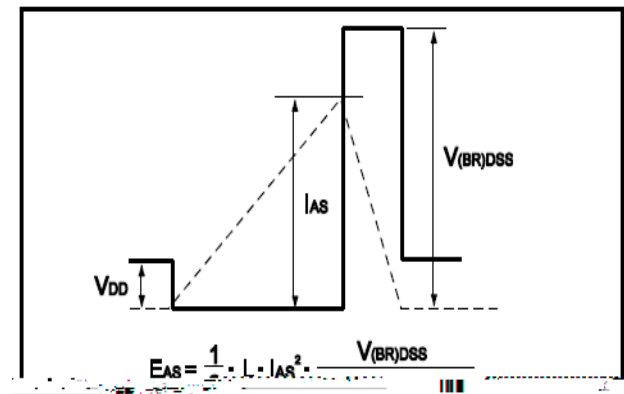

Fig.6 Avalanche Waveform





sions DFN5x6

Unit: mm

