





Gate Resistance	Rg	f = 1MHz		1.5		
Input capacitance	Ciss	f = 1MHz				
		V				

N Channel characteristics curve

Fig.1 Power Dissipation



Fig.2 Typical output Characteristics

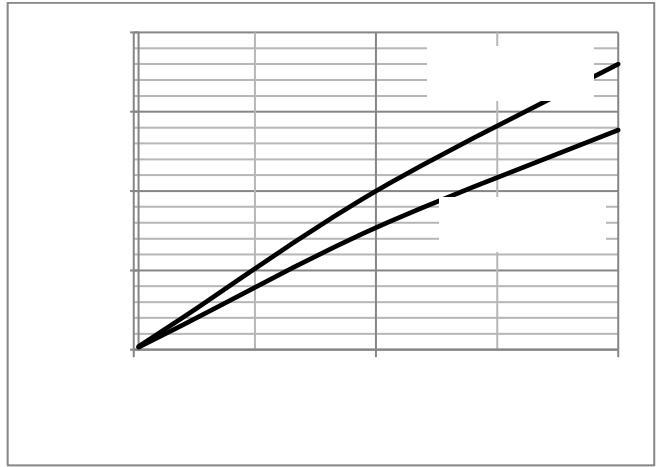

Fig.3 Threshold Voltage V.S Junction Temperature

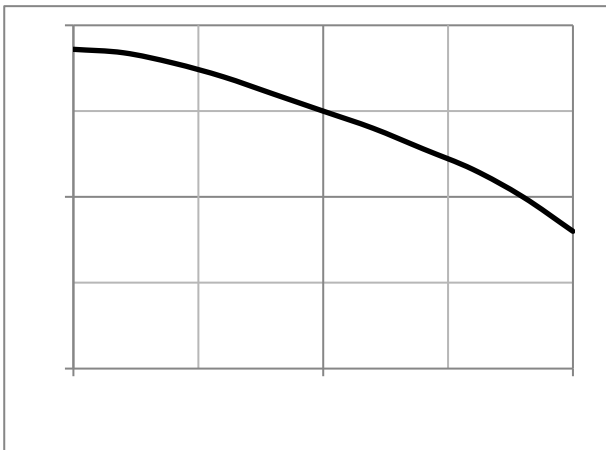
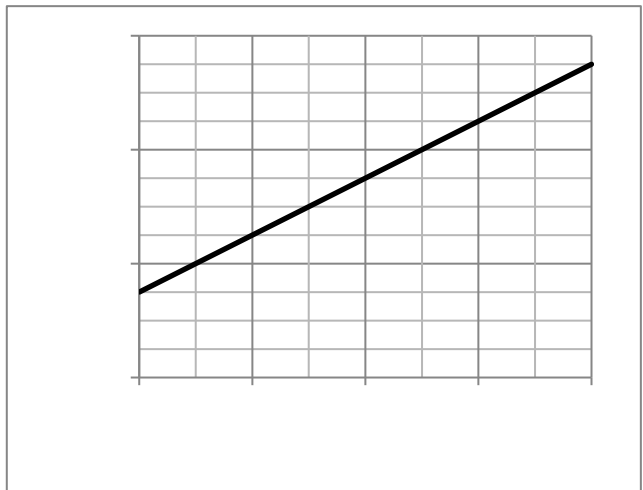
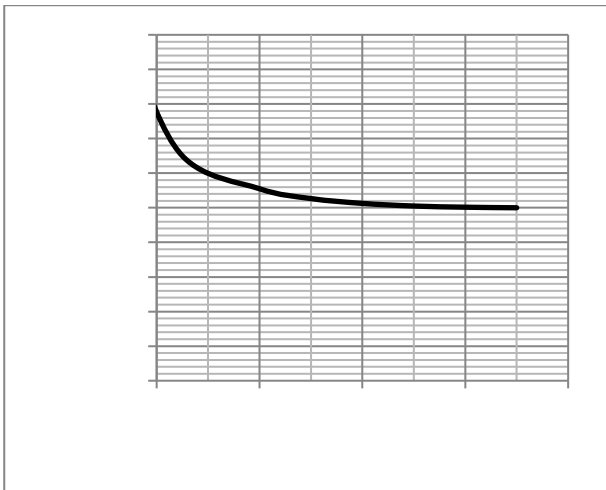
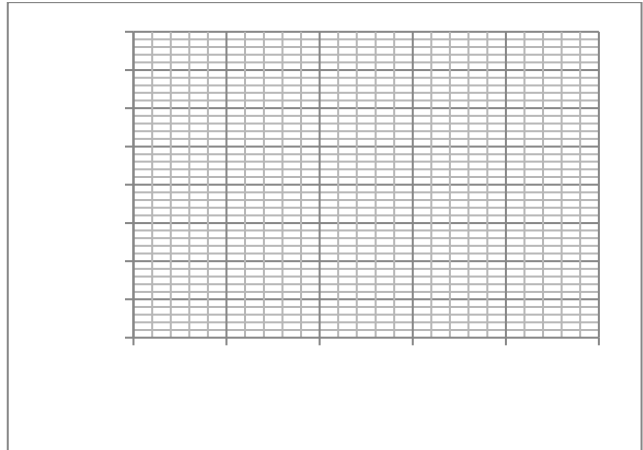

Fig.4 Resistance V.S Drain Current



P Channel characteristics curve

Fig.1 Power Dissipation Derating Curve

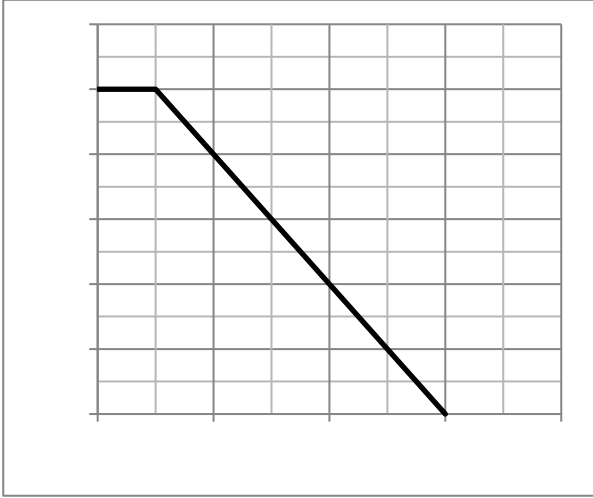

Fig.2 Typical output Characteristics

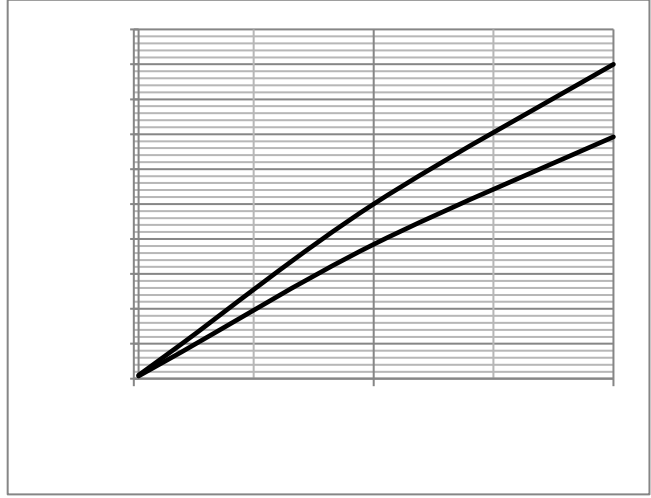

Fig.3 Threshold Voltage V.S Junction Temperature

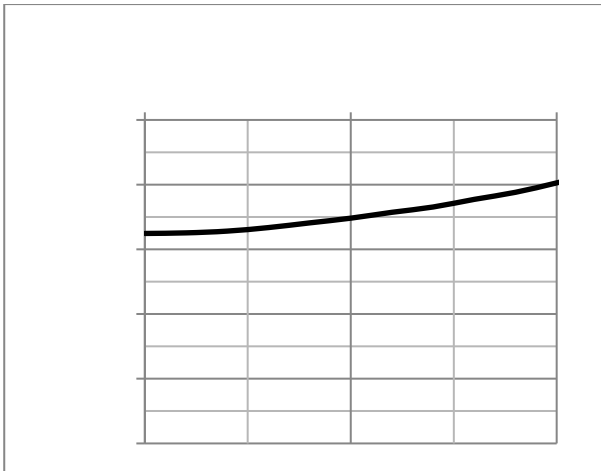
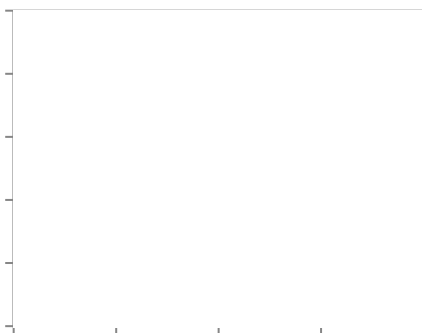
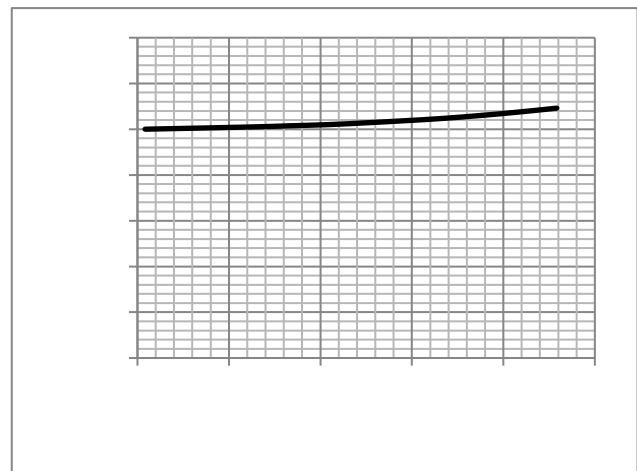

Fig.4 Resistance V.S Drain Current



Test Circuit

Fig.1 Switching Time Measurement Circuit

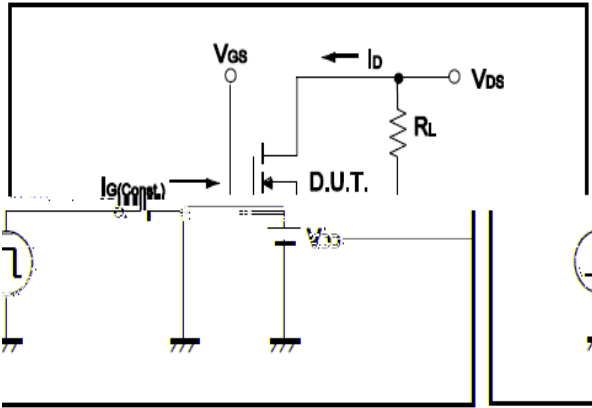

Fig.2 Gate Charge Waveform

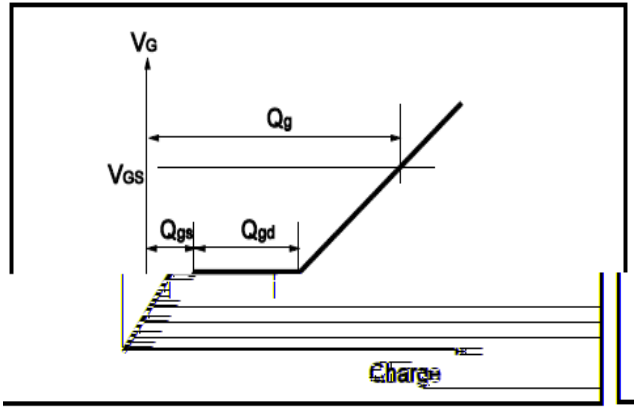

Fig.3 Switching Time Measurement Circuit

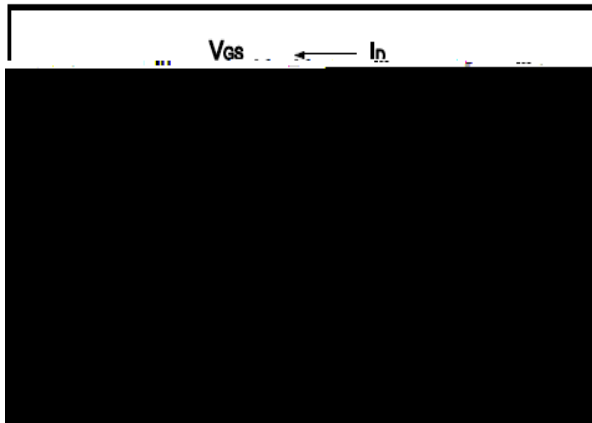

Fig.4 Gate Charge Waveform

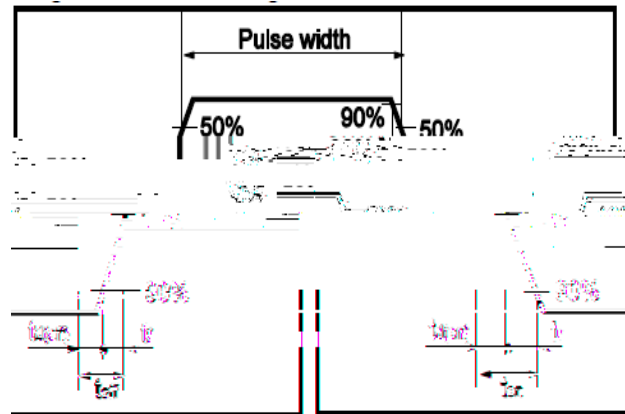

Fig.5 Avalanche Measurement Circuit

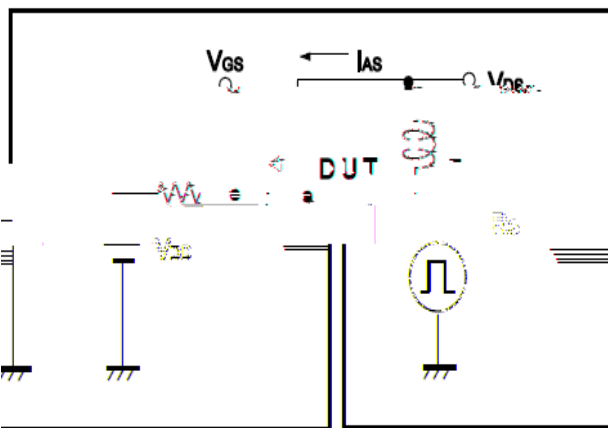

Fig.6 Avalanche Waveform

