

**Ordering Information:****Absolute Maximum Ratings** $T_C = 25$

Parameter	Symbol	Rating	Unit
Drain-Source Voltage	V_{DS}	100	V
Gate-Source Voltage	V_{GS}	± 20	V
Continuous Drain Current	$I_{D@T_C=25}$	175	A
	$I_{D@T_C=75}$	133	A
	$I_{D@T_C=100}$	110	A
Pulsed Drain Current	I_{DM}		



Thermal resistance

Parameter	Symbol	Min.	Typ.	Max.	Unit
Thermal resistance, junction - case	R _{thJC}	-	-	1.0	° C/W

Fig.1 Gate-Charge Characteristics

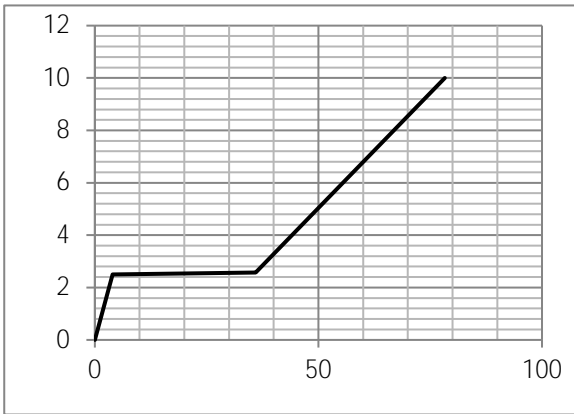

Fig.2 Capacitance Characteristics

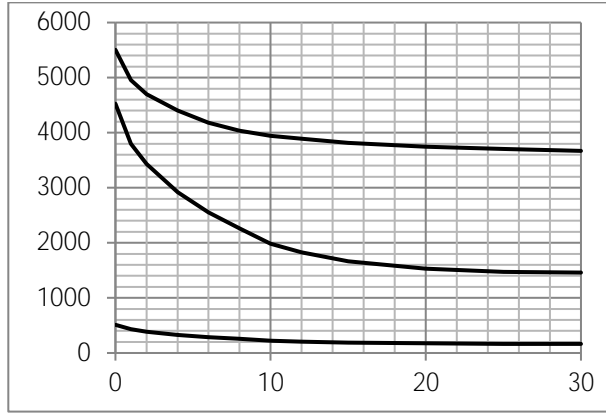

Fig.3 Power Dissipation

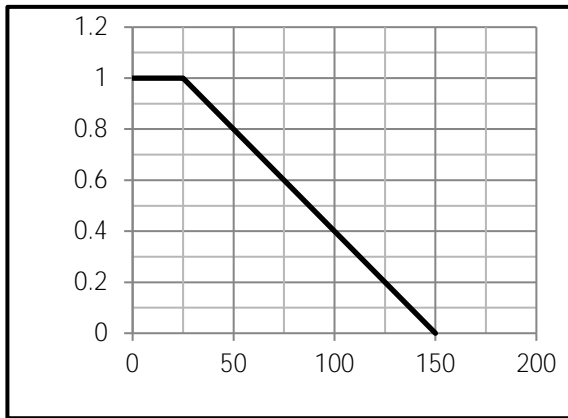

Fig.4 Typical output Characteristics

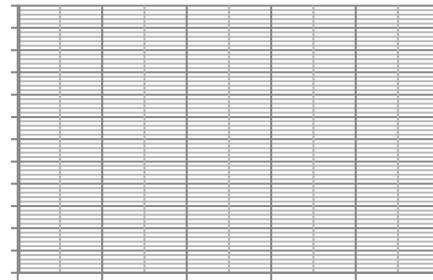

Fig.5 Threshold Voltage V.S Junction Temperature

Fig.6 Resistance V.S Drain Current

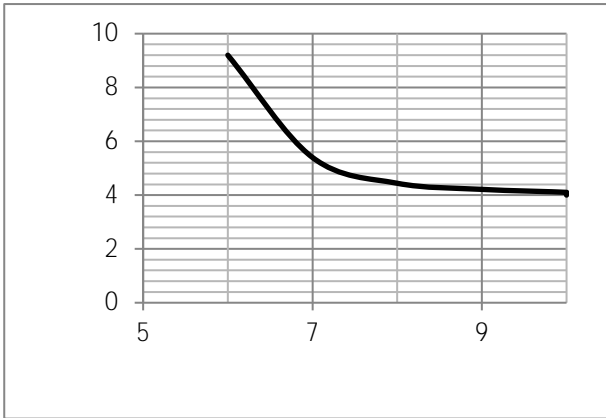

Fig.9 SOA Maximum Safe Operating Area

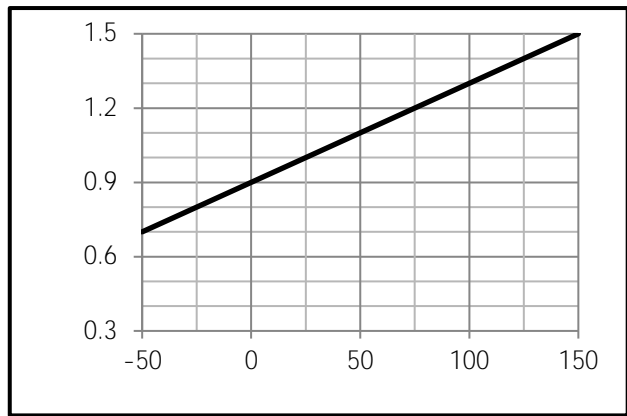

Fig.10 I_D -Junction Temperature

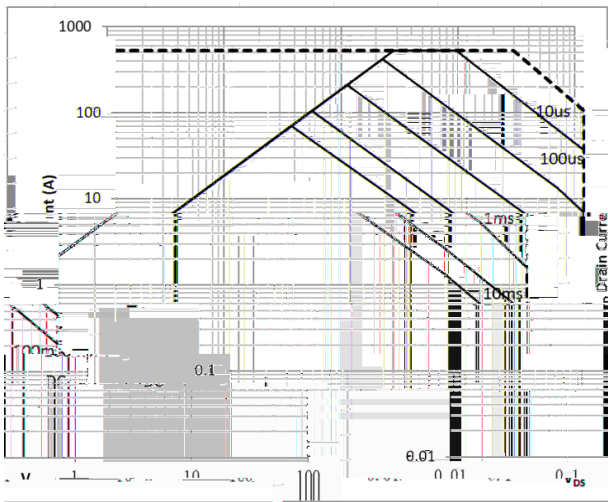

Fig.11 Switching Time Measurement Circuit

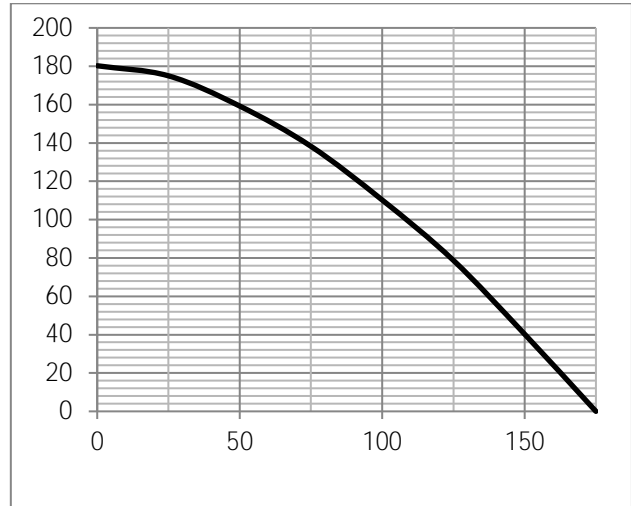

Fig.12 Gate Charge Waveform

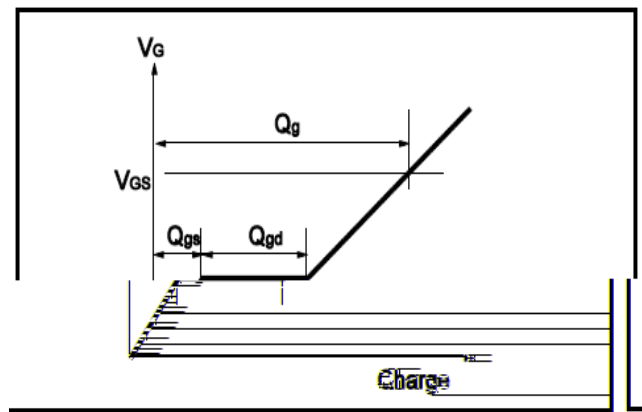
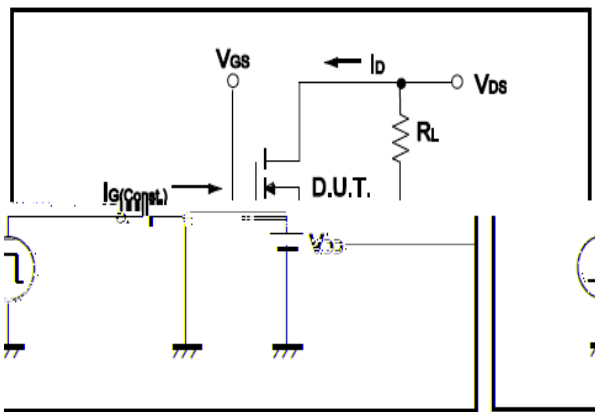

Fig.13 Switching Time Measurement Circuit

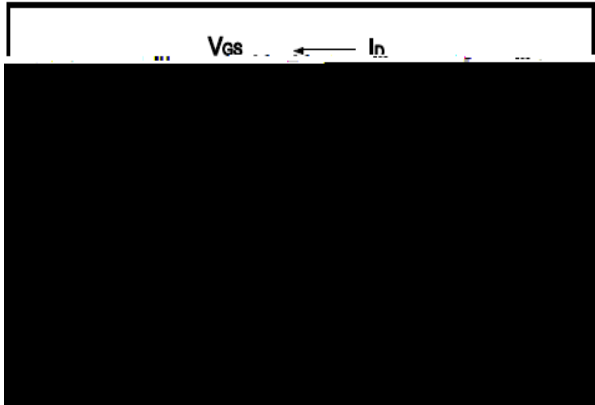

Fig.14 Gate Charge Waveform

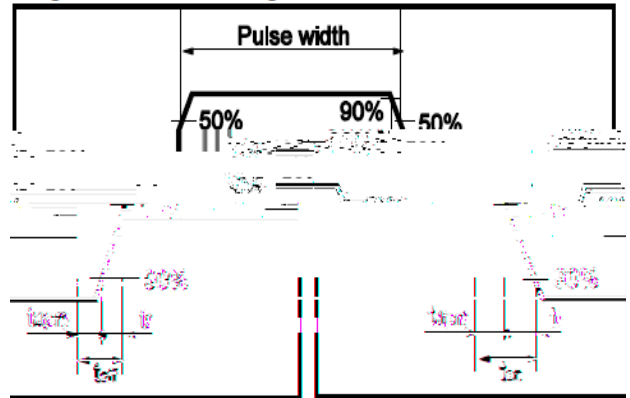

Fig.15 Avalanche Measurement Circuit

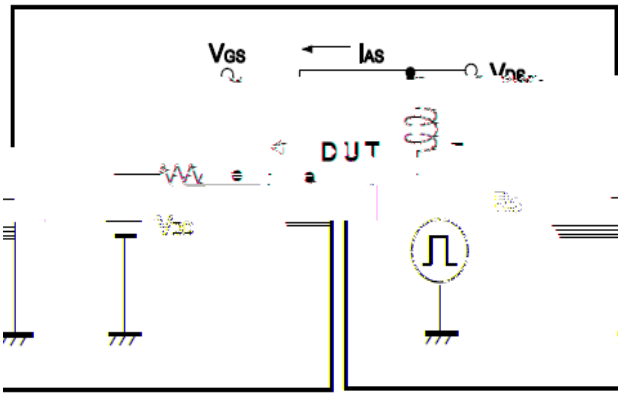
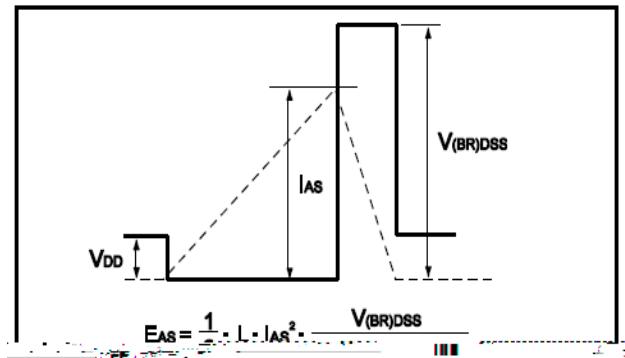

Fig.16 Avalanche Waveform





Dimensions TO-220

Unit mm

	2 . .		2
	0.		.			0 2	
	. .		2.		.		2
	.		. .				