



Ordering Information:

Absolute Maximum Ratings $T_C = 25$

Parameter	Symbol	Rating	Unit
Drain-Source Voltage	V_{DS}	60	V
Gate-Source Voltage	V_{GS}	± 20	V
Continuous Drain Current	$I_D@T_C=25$	5.5	A
	$I_D@T_C$		



Thermal resistance

Parameter	Symbol	Min.	Typ.	Max.	Unit
-----------	--------	------	------	------	------

Fig.1 Power Dissipation Derating Curve

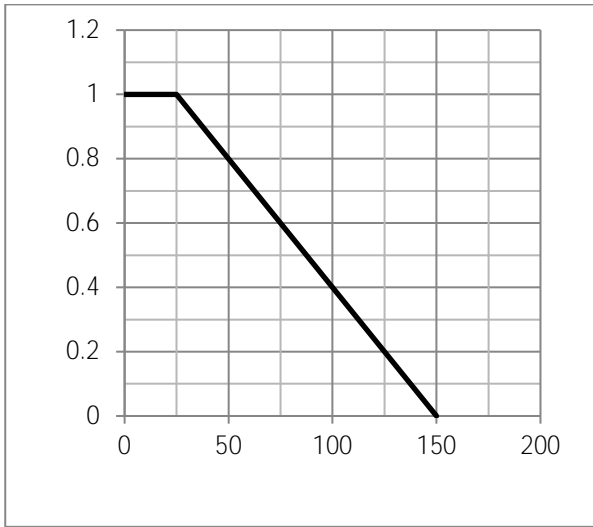

Fig.2 Typical output Characteristics

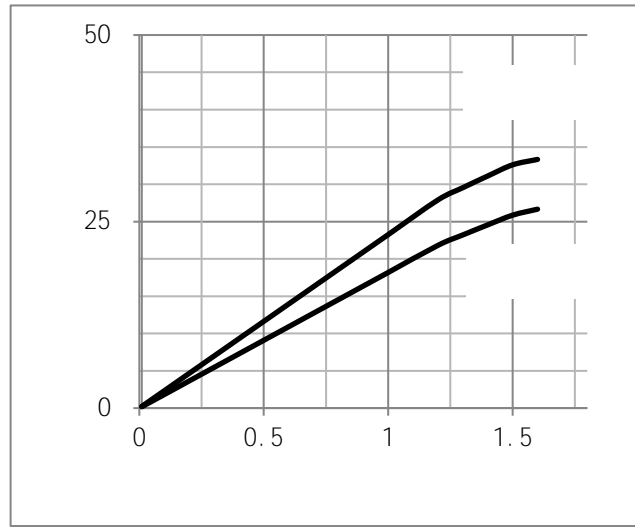

Fig.3 Threshold Voltage V.S Junction Temperature

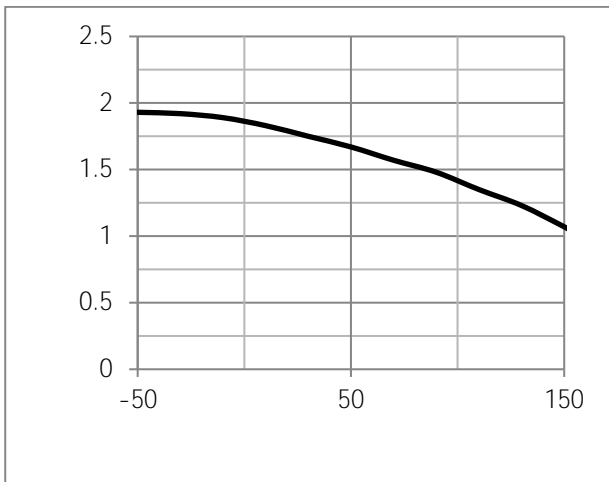

Fig.4 Resistance V.S Drain Current

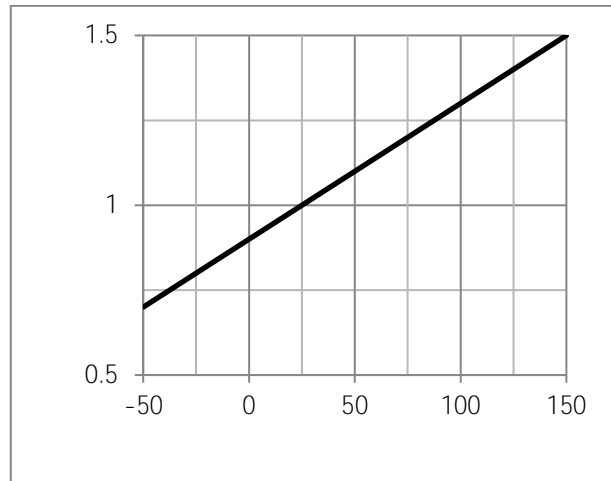
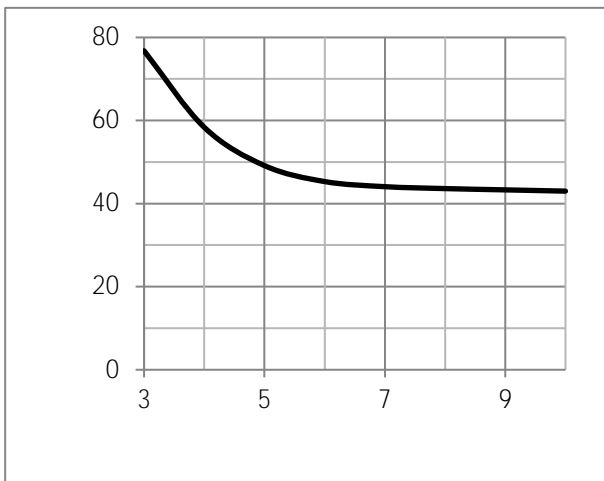
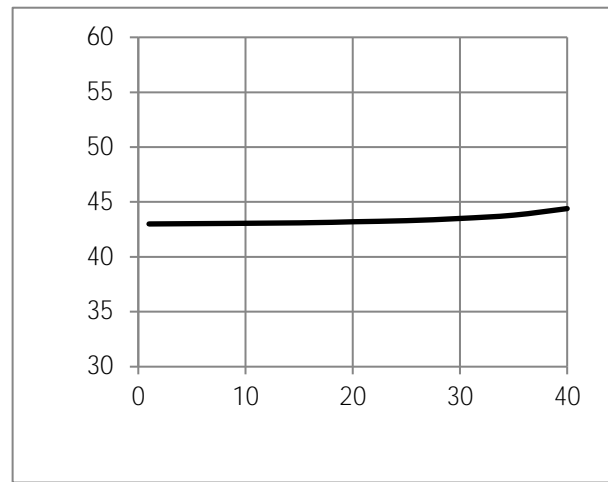

Fig.7 Switching Time Measurement Circuit

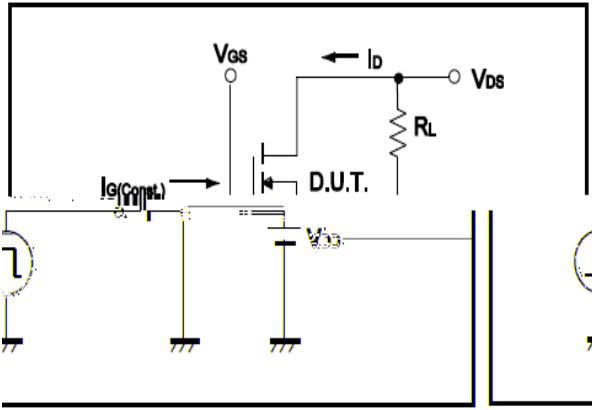

Fig.8 Gate Charge Waveform

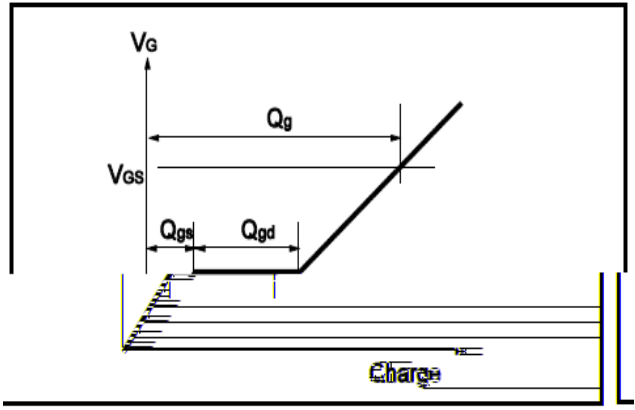

Fig.9 Switching Time Measurement Circuit

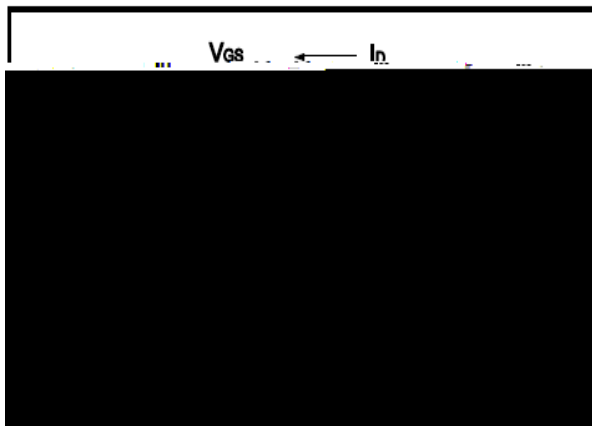

Fig.10 Gate Charge Waveform

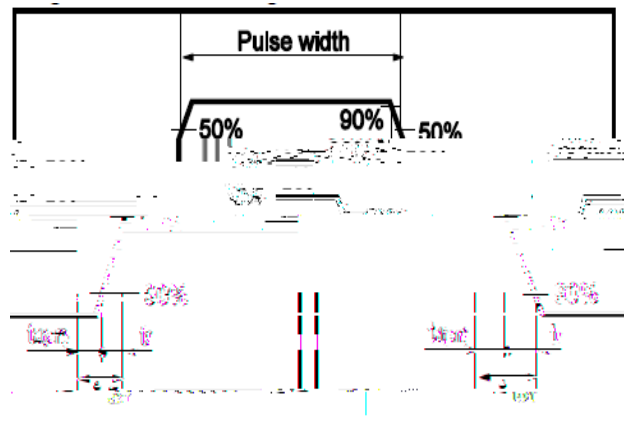

Fig.11 Avalanche Measurement Circuit

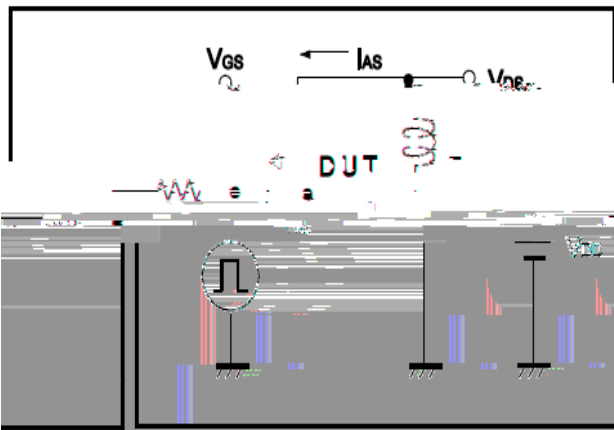
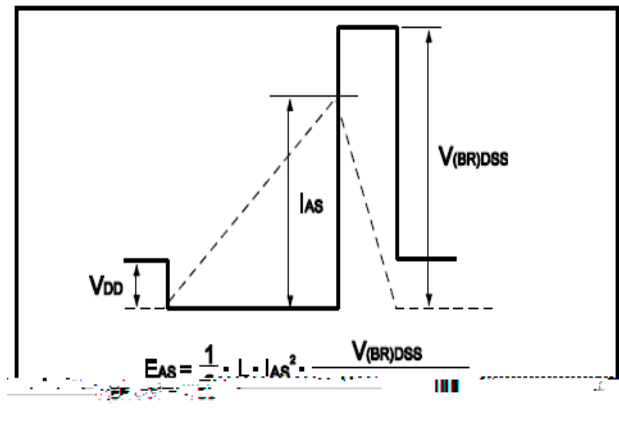

Fig.12 Avalanche Waveform





Dimensions(SOP8s) 0.33() JE T 0.87 0.25 4.0 10.82 5.0 Tm 0.53g 0.2 0.2 2.7e2*EMC Span M C D ng (en