



**Ordering Information:**

**Absolute Maximum Ratings**  $T_C = 25$

Parameter	Symbol	Rating	Unit
Drain-Source Voltage	$V_{DS}$	45	V
Gate-Source Voltage	$V_{GS}$	$\pm 20$	V
Continuous Drain Current	$I_{D@T_C=25}$	10	A
	$I_{D@T_C=75}$	7.6	A

|

**Thermal resistance**

Parameter	Symbol	Min.	Typ.	Max.	Unit
Thermal resistance, junction - case	$R_{thJC}$	-	-	36	$^{\circ}C/W$
Thermal resistance, junction - ambient	$R_{thJA}$	-	-	180	$^{\circ}C/W$
Soldering temperature, wavesoldering for 10s	$T_{sold}$	-	-	265	$^{\circ}C$

**Electronic Characteristics**

Parameter	Symbol	Condition	Min.	Typ	Max.	Unit
Drain-Source Breakdown Voltage	$BV_{DSS}$	$V_{GS} = 0V, I_D = 250\mu A$	40			V
Gate Threshold Voltage	$V_{GS(TH)}$	$V_{GS} = V_{DS}, I_D = 250\mu A$	1.2		2.5	V
Drain-Source Leakage Current	$I_{DSS}$	$V_{DS} = 40V, V_{GS} = 0V$			1.0	$\mu A$
Gate- Source Leakage Current	$I_{GSS}$	$V_{GS} = \pm 20V, V_{DS} = 0V$			100	nA
Static Drain-source On Resistance		$V_{GS} = 10V, I_D = 13A$				
		$V_{GS} = 4.5V, I_D = 10A$				
Forward Transconductance	$g_{FS}$	$V_{DS} = 10V, I_D = 5A$				
Source-drain voltage	$V_{SD}$	$I_S = 13A$				

**Electronic Characteristics**

Parameter	Symbol	Condition	Min.	Typ	Max.	Unit
Input capacitance	$C_{iss}$	$f = 1MHz$	-	1150	-	pF
Output capacitance	$C_{oss}$		-	290	-	
Reverse transfer capacitance	$C_{rss}$		-	200	-	

**Gate Charge characteristics( $T_a = 25^{\circ}C$ )**

Parameter	Symbol	Condition	Min.	Typ	Max.	Unit
Total gate charge	$Q_g$	$V_{DD} = 25V$	-	15	-	nC
Gate - Source charge	$Q_{gs}$	$I_D = 8A$	-	6	-	
Gate - Drain charge	$Q_{gd}$	$V_{GS} = 10V$	-	8	-	

Note: Pulse Test : ;

Device mounted on FR-4 substrate PC board, 2oz copper, with thermal bias to bottom layer 1inch square copper plate

Fig.1 Power Dissipation Derating Curve

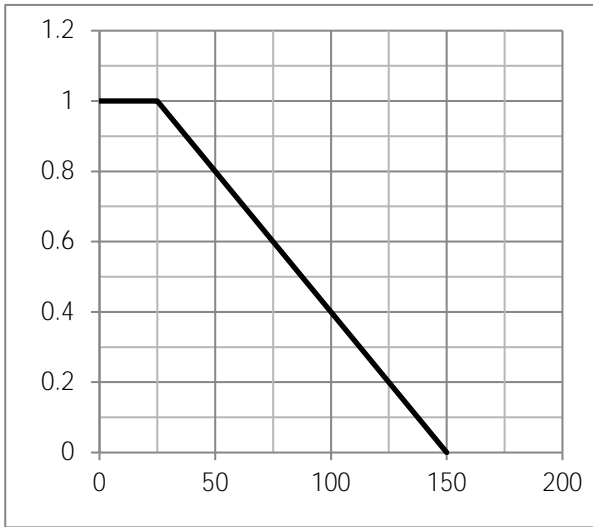

Fig.2 Typical output Characteristics

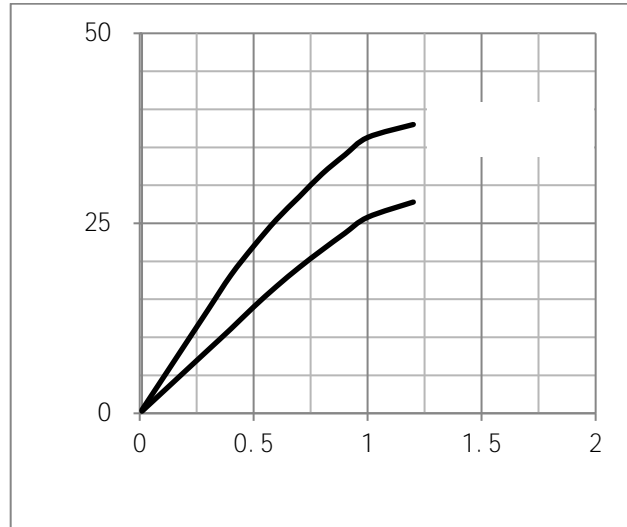

Fig.3 Threshold Voltage V.S Junction Temperature

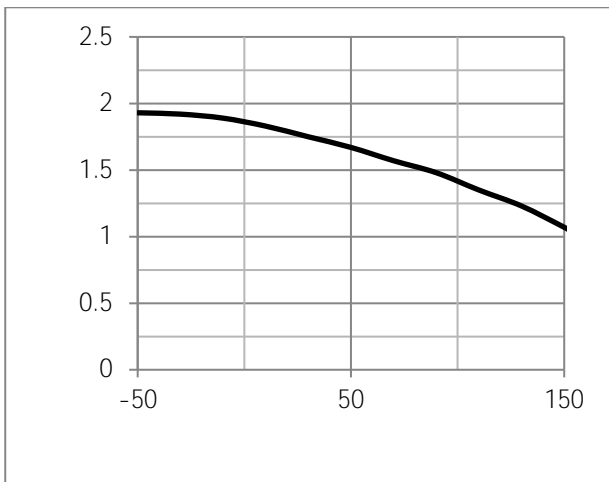

Fig.4 Resistance V.S Drain Current

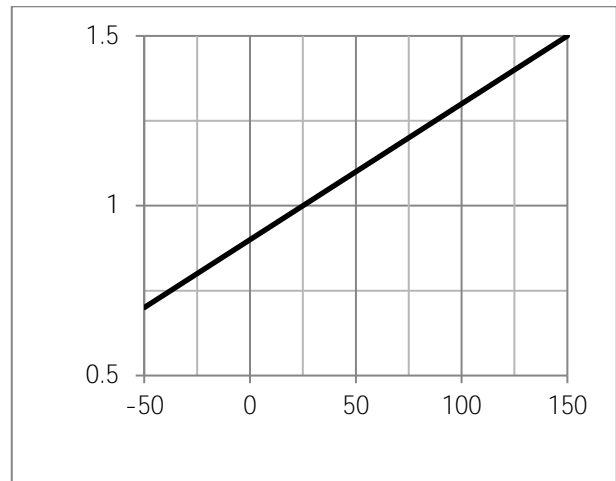
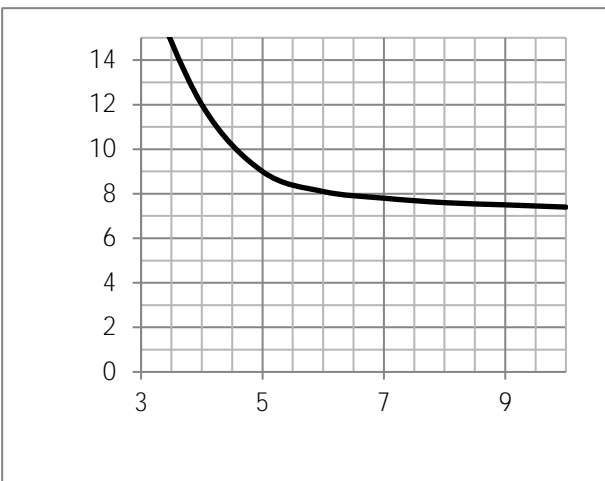
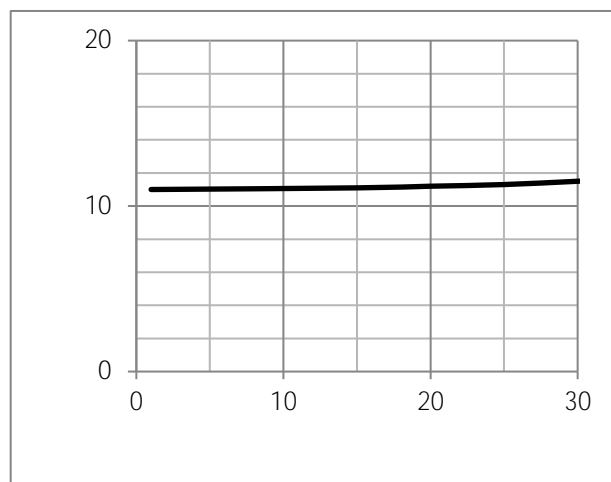

Fig.7 Switching Time Measurement Circuit

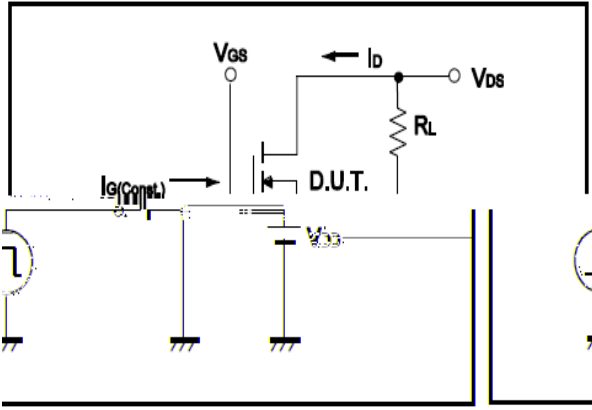

Fig.8 Gate Charge Waveform

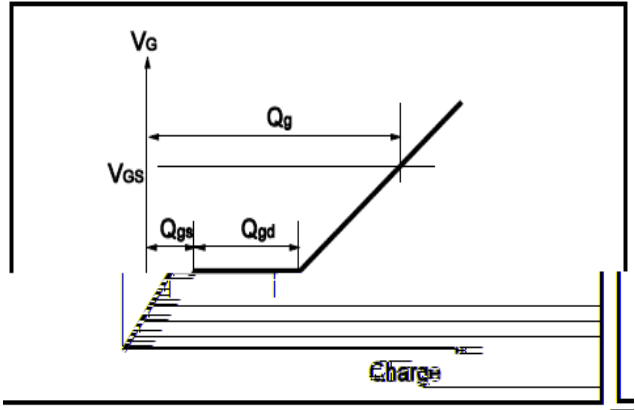

Fig.9 Switching Time Measurement Circuit

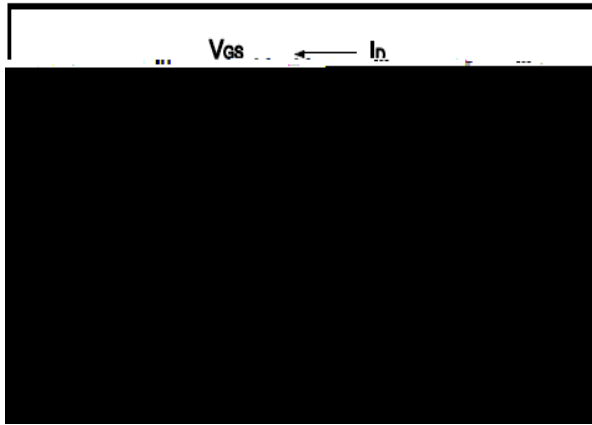

Fig.10 Gate Charge Waveform

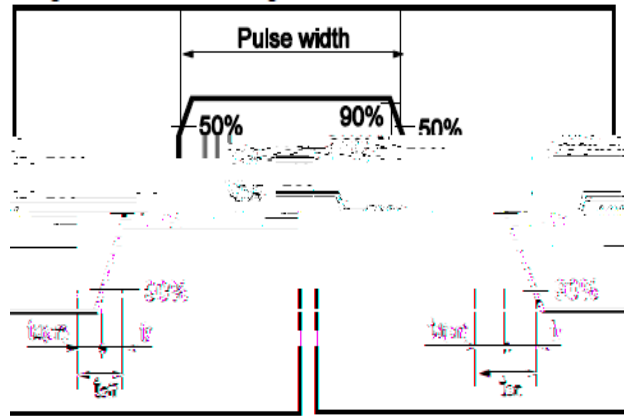

Fig.11 Avalanche Measurement Circuit

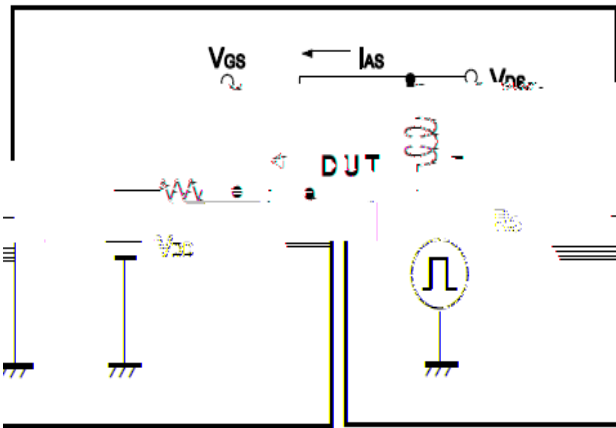
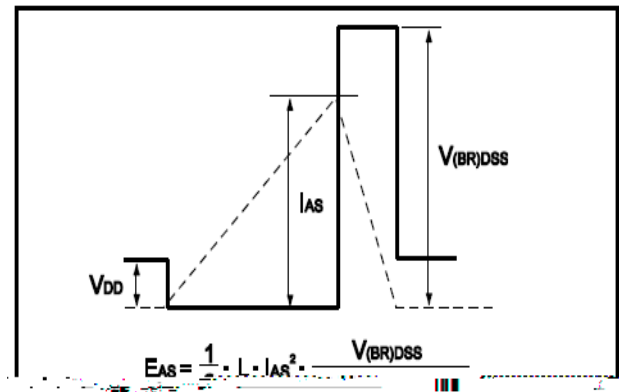

Fig.12 Avalanche Waveform





**Dimensions(SOP8)**