

Product Summary

The ZM045N03M combines advanced trench MOSFET technology with a low resistance package to provide extremely low $R_{DS(ON)}$. This device is ideal for load switch and battery protection applications.

Advance high cell density Trench technology
 $R_{DS(ON)}$ to minimize conductive loss

nd Synchronous Rectifier

$T_C = 25$

Parameter	Symbol	Rating	Unit
Drain-Source Voltage	V_{DS}	30	V
Gate-Source Voltage	V_{GS}	± 20	V
Continuous Drain Current	$I_{D@T_C=25}$	60	A
	$I_{D@T_C=75}$	45	A
	$I_{D@T_C=100}$	38	A
Pulsed Drain Current	I_{DM}	150	A
Total Power Dissipation	$P_D@T_C=25$	43	W
Total Power Dissipation	$P_D@T_A=25$	2.3	W
Operating Junction Temperature	T_J	-55 to 150	
Storage Temperature	T_{STG}	-55 to 150	
Single Pulse Avalanche Energy	E_{AS}	260	mJ



Thermal resistance

Parameter	Symbol	Min.	Typ.	Max.	Unit
Thermal resistance, junction - case	R _{thJC}	-	-	2.9	° C/W
Thermal resistance, junction - ambient	R _{thJA}	-	-	54	° C/W
Soldering temperature, wavesoldering for 10s	T _{sold}	-	-	265	° C



Parameter **Symbol** **Condition**



Fig.1 Power Dissipation

Fig.2 Typical output Characteristics

Fig.3 Threshold Voltage V.S Junction Temperature Fig.4 Resistance V.S Drain Current

Fig.7

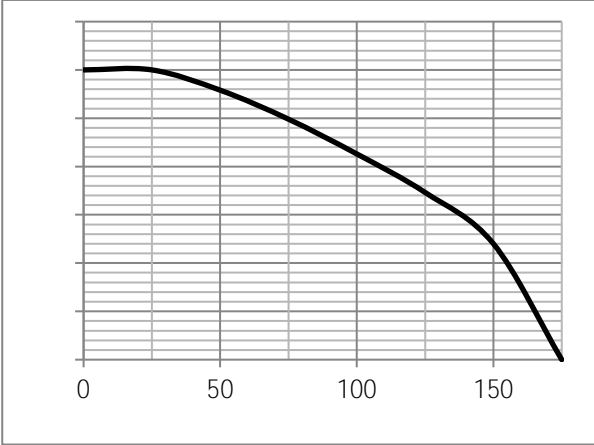

Fig.8 Switching Time Measurement Circuit

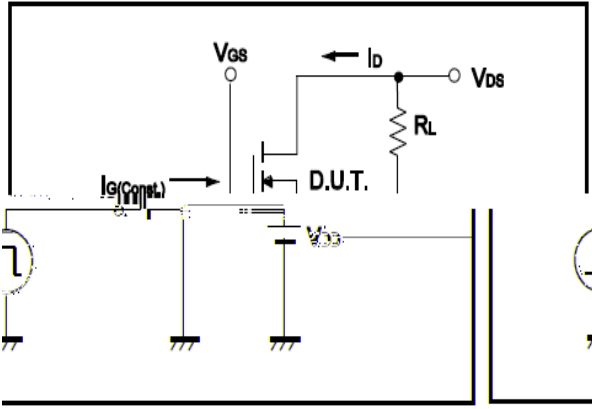

Fig.9 Gate Charge Waveform

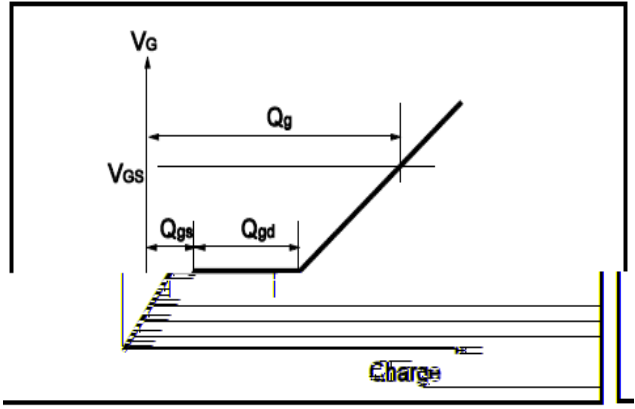

Fig.10 Switching Time Measurement Circuit

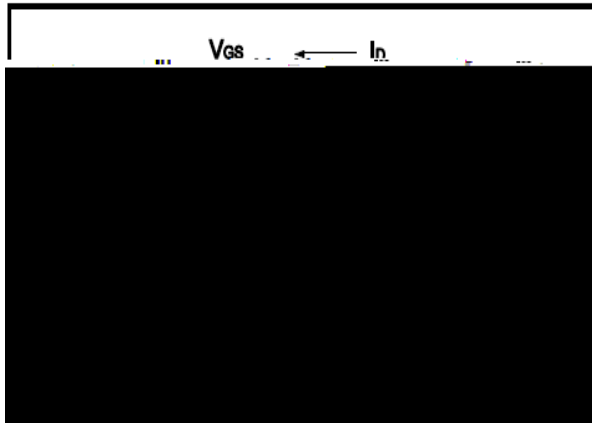

Fig.11 Gate Charge Waveform

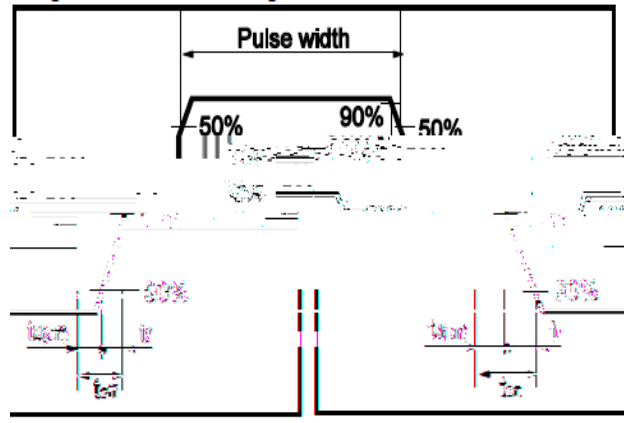
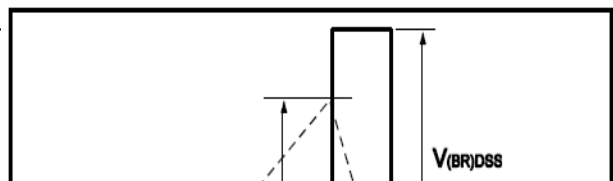

Fig.12 Avalanche Measurement Circuit

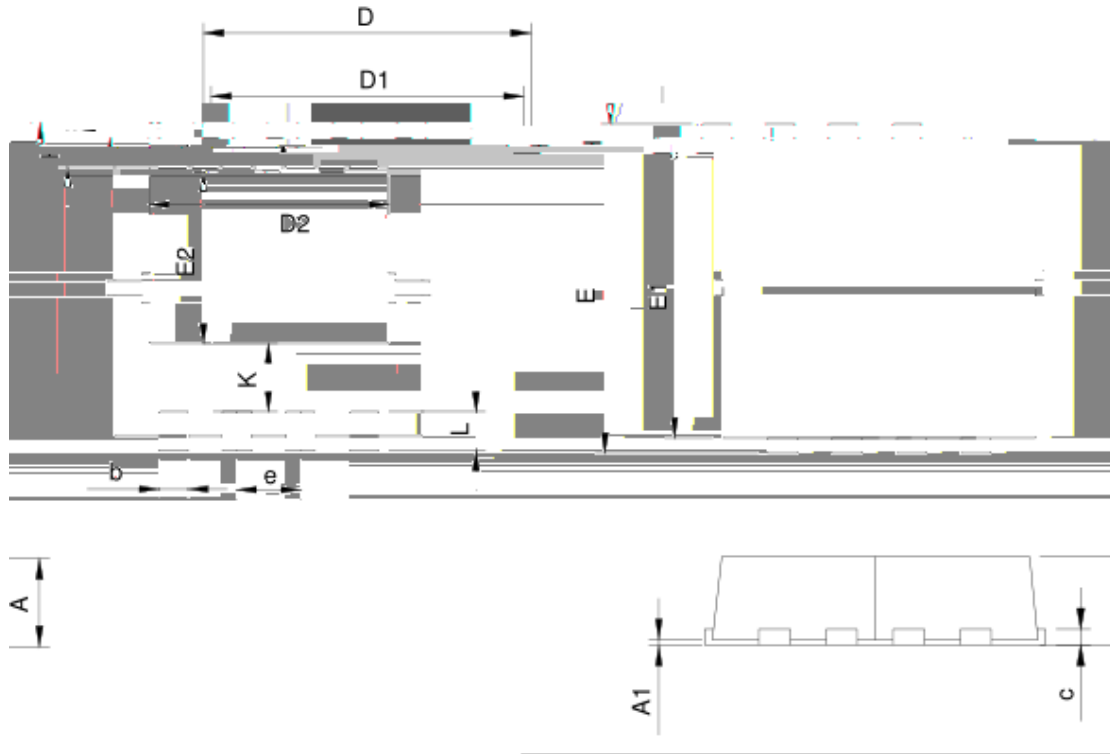

Fig.13 Avalanche Waveform





Unit mm



SY	DFN3.3x3.3-8	RECOMMENDED LAND PATTERN			
		MILS		MM	
		MIN.	MAX.	MIN.	MAX.
0.47	A	0.70	1.00	0.028	0.039
0.014	A1	0.00	0.05	0.000	0.002
0.008	b			0.25	0.35
0.138	c			0.14	0.20
0.128	D			3.10	3.50
	D1			3.05	3.25
0.65	D2	2.35	2.55	0.093	0.100
	E	3.10	3.58	0.122	0.138
	E1	2.90	3.10	0.114	0.122
	E2	2.35	2.55	0.093	0.100
	e		0.65 BSC		0.026 BSC
	H	0.32	0.52	0.013	0.020
	K	0.59	0.79	0.023	0.031
		0.25	0.35	0.010	0.022