

Product Summary

The ZM075P03M combines advanced trench MOSFET technology with a low resistance package to provide extremely low $R_{DS(ON)}$.

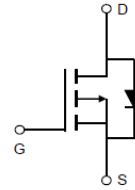

Trench technology

$R_{DS(ON)}$ to minimize conductive loss

nd Synchronous Rectifier

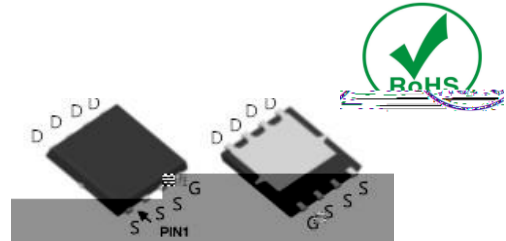

Part NO.	ZM075P03M
Marking	075P03
Packing Information	REEL TAPE
Basic ordering unit (pcs)	5000

$T_C = 25$

Parameter	Symbol	Rating	Unit
Drain-Source Voltage	V_{DS}	-30	V
Gate-Source Voltage	V_{GS}	± 25	V
Continuous Drain Current	$I_{D@TC=25}$	-50	A
	$I_{D@TC=75}$	-38	A
	$I_{D@TC=100}$	-31.5	A
Pulsed Drain Current	I_{DM}	-130	A
Total Power Dissipation	$P_D@T_C=25$	46	W
Total Power Dissipation	$P_D@T_A=25$	2.3	W
Operating Junction Temperature	T_J	-55 to 150	
Storage Temperature	T_{STG}	-55 to 150	
Single Pulse Avalanche Energy@L=0.1mH	E_{AS}	180	mJ
Avalanche Current@L=0.1mH	I_{AS}	60	A

Thermal resistance

Parameter	Symbol	Min.	Typ.	Max.	Unit
Thermal resistance, junction - case	R_{thJC}	-	-	2.7	$^{\circ}C/W$
Thermal resistance, junction - ambient	R_{thJA}	-	-	53	$^{\circ}C/W$
Soldering temperature, wavesoldering for 10s	T_{sold}	-	-	265	$^{\circ}C$

Parameter	Symbol	Condition	Min.	Typ	Max.	Unit
Drain-Source Breakdown Voltage	BV_{DSS}	$V_{GS}=0V, I_D=-250\mu A$	-30			V
Gate Threshold Voltage	$V_{GS(TH)}$	$V_{GS}=V_{DS}, I_D=-250\mu A$	-1.2	-1.9	-2.5	V
Drain-Source Leakage Current	I_{DSS}	$V_{DS}=-30V, V_{GS}=0V$			-1.0	μA
Gate- Source Leakage Current	I_{GSS}	$V_{GS}=\pm 20V, V_{DS}=0V$			100	nA
Static Drain-source On Resistance		$V_{GS}=-10V, I_D=-20A$				
		$V_{GS}=-4.5V, I_D=-10A$				
Forward Transconductance	g_{FS}	$V_{DS}=-10V, I_D=-5A$				
Source-drain voltage	V_{SD}	$I_S=-20A$				

Parameter	Symbol	Condition	Min.	Typ	Max.	Unit
Input capacitance	C_{iss}	$V_{GS}=0V, V_{DS}=-25V$ $f = 1MHz$	-	2800	-	pF
Output capacitance	C_{oss}		-	420	-	
Reverse transfer capacitance	C_{rss}		-	280	-	

Switching Parameters($T_a = 25^{\circ}C$)

Parameter	Symbol	Condition	Min.	Typ	Max.	Unit
Total gate charge	Q_g	$V_{DD}=-25V$ $I_D=-8A$ $V_{GS}=-10V$	-	27	-	nC
Gate - Source charge	Q_{gs}		-	8.6	-	
Gate - Drain charge	Q_{gd}		-	13.8	-	
Body Diode Reverse Recovery Time	t_{rr}	$I_F=20A,$ $di/dt=100A/\mu s$		22		nS
Body Diode Reverse Recovery Charge	Q_{rr}	$I_F=20A,$ $di/dt=100A/\mu s$		105		nC

Note:

Device mounted on FR-4 substrate PC board, 2oz copper, with thermal bias to bottom layer 1inch square copper plate



Fig.1 Power Dissipation Derating Curve

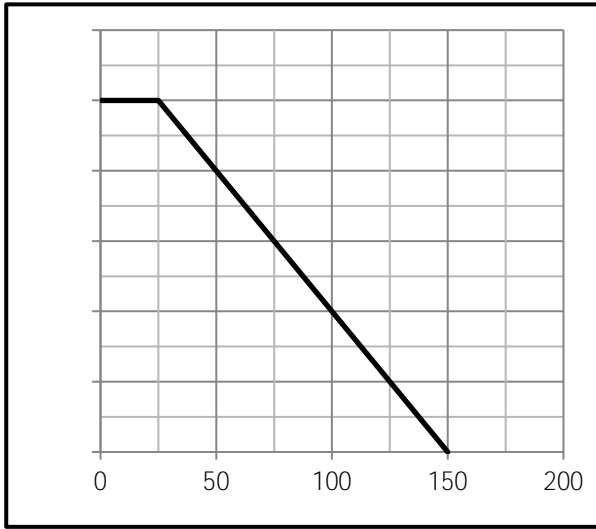

Fig.2 Typical output Characteristics

Fig.3 Threshold Voltage V.S Junction Temperature

Fig.4 Resistance V.S Drain Current

Fig.7 Gate-Charge Characteristics

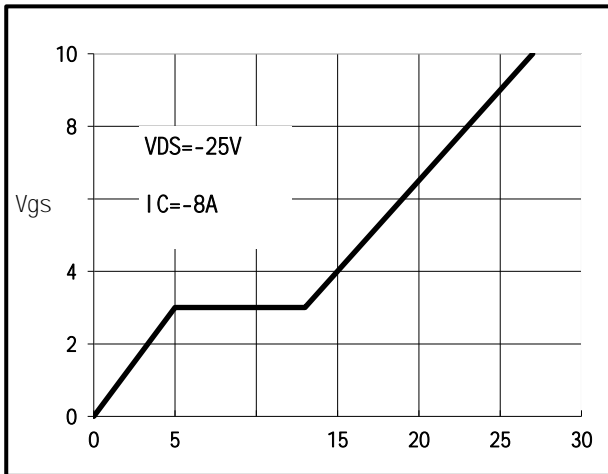

Fig.8 Capacitance Characteristics

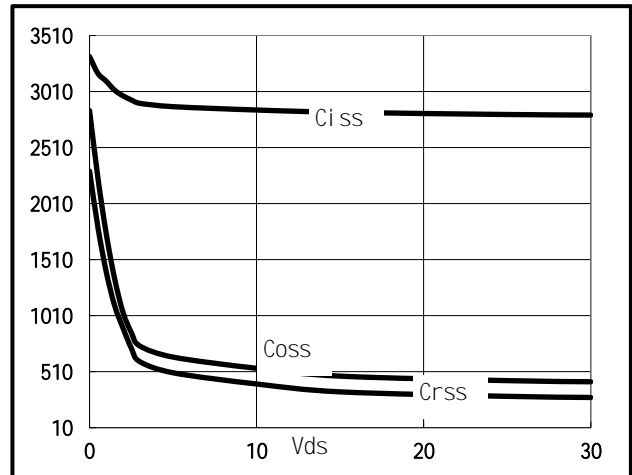

Fig.10 ID-Junction Temperature

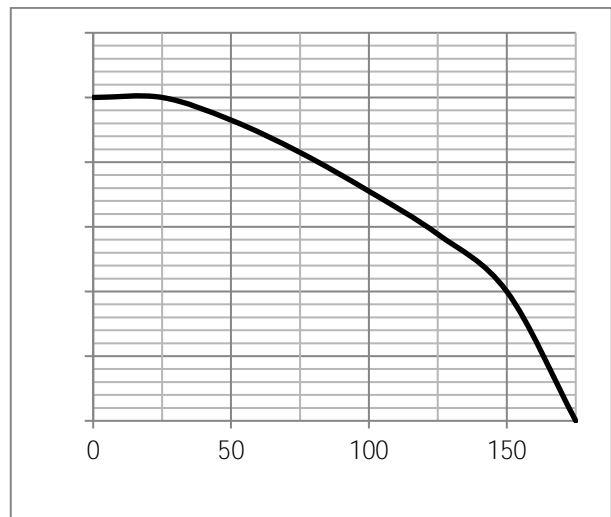
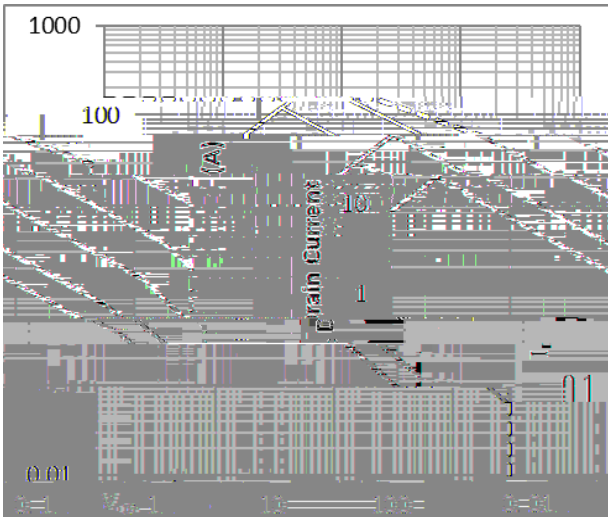

Fig.11 Switching Time Measurement Circuit

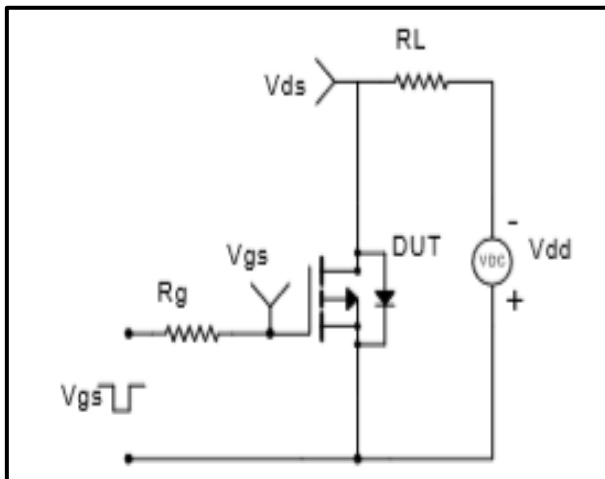
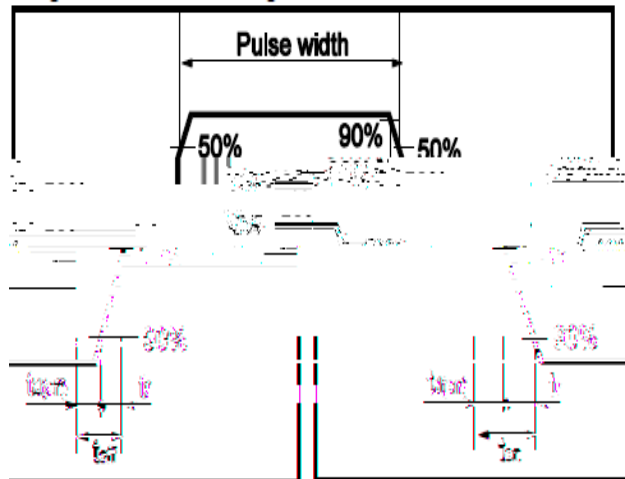

Fig.12 Gate Charge Waveform





(DFN3 3)

Unit mm

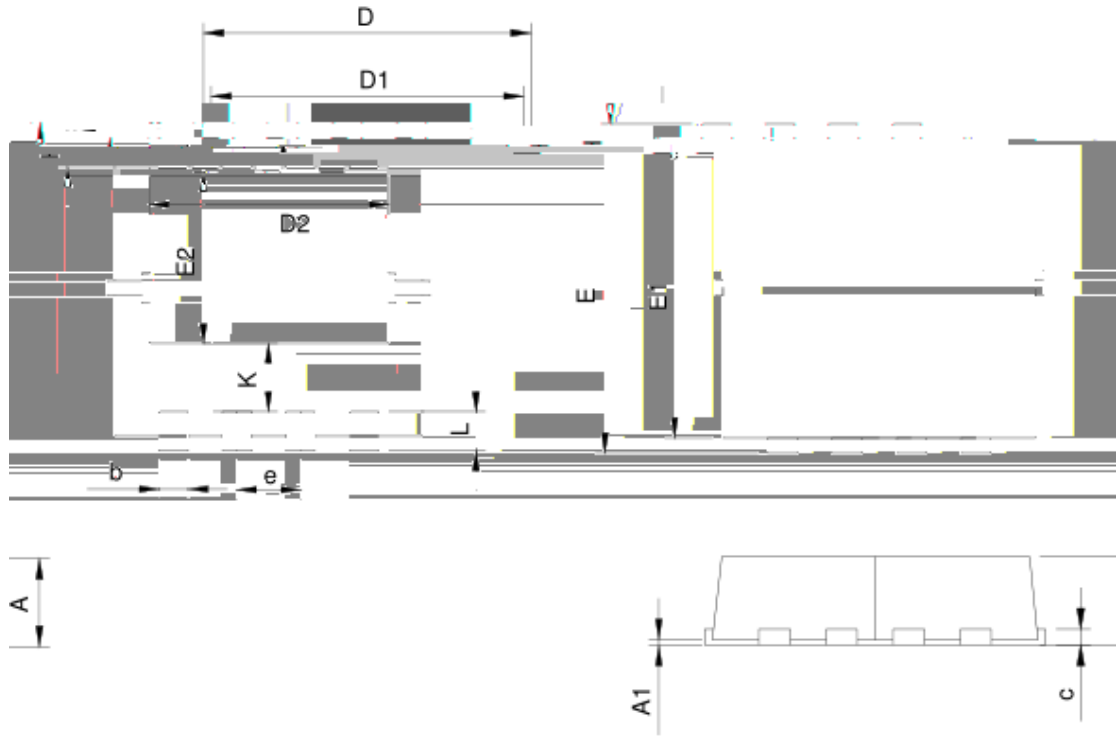

DFN3.3x3.3-8		RECOMMENDED LAND PATTERN			
		MILLIMETERS		INCHES	
		MIN.	MAX.	MIN.	MAX.
A	0.70	1.00	0.028	0.039	
A1	0.00	0.05	0.000	0.002	
b	0.25	0.35	0.010		
c	0.14	0.20	0.006		
D	3.10	3.50	0.122		
D1	3.05	3.25	0.120		
D2	2.35	2.55	0.093	0.100	
E	3.10	3.50	0.122	0.138	
E1	2.90	3.10	0.114	0.122	
E2	0.65	0.75	0.026	0.035	
e	0.65 BSC	0.52	0.013	0.020	
H	0.32	0.52	0.013	0.020	
K	0.59	0.79	0.023	0.031	
	0.25	0.35	0.010	0.022	