



Ordering Information:

Absolute Maximum Ratings $T_C = 25$

Parameter	Symbol	Rating	Unit
Drain-Source Voltage	V_{DS}	100	V
Gate-Source Voltage	V_{GS}	± 20	V

**Thermal resistance**

Parameter	Symbol	Min.	Typ.	Max.	Unit
Thermal resistance, junction - case	R_{thJC}	-	-	1.5	C/W
Thermal resistance, junction - ambient	R_{thJA}	-	-	37	C/W
Soldering temperature, wave soldering for 10s	T_{sold}	-	-	265	C

Electronic Characteristics

Parameter	Symbol	Condition	Min.	Typ.	Max.	Unit
Drain-Source Breakdown Voltage	BV_{DSS}	$V_{GS} = 0V, I_D = 250\mu A$	100			V
Gate Threshold Voltage	$V_{GS(TH)}$	$V_{GS} = V_{DS}, I_D = 250\mu A$	1.2		2.5	V
Drain-Source Leakage Current	I_{DSS}	$V_{DS} = 100V, V_{GS} = 0V$			1.0	μA
Gate- Source Leakage Current	I_{GSS}	$V_{GS} = \pm 20V, V_{DS} \neq 0V$				

Note: Pulse Test :

;

Fig.1 Gate-Charge Characteristics

Fig.2 Capacitance Characteristics

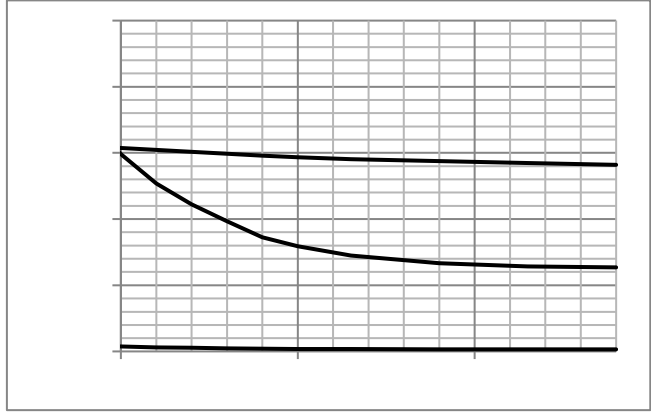
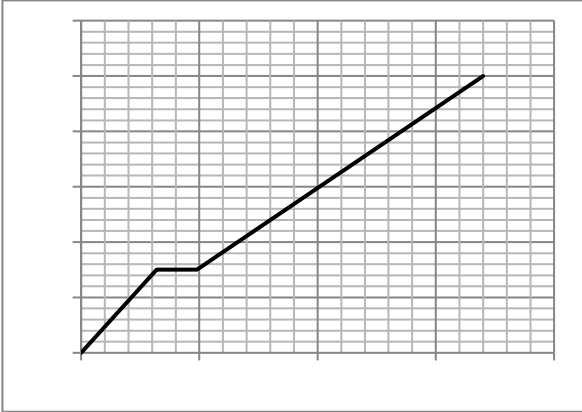

Fig.3 Power Dissipation

Fig.4 Typical output Characteristics

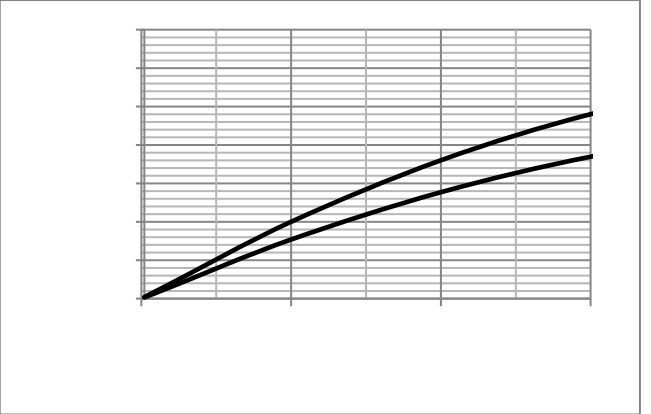
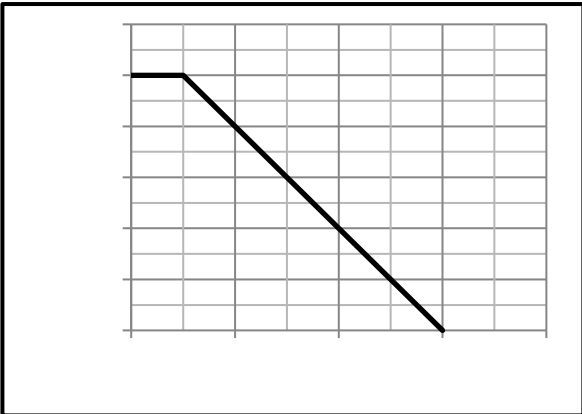
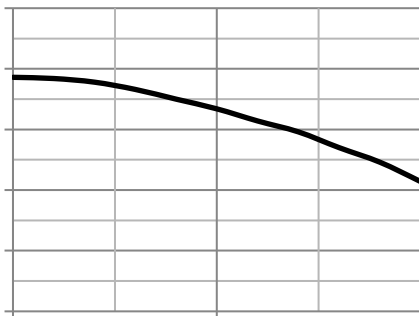

Fig.5 Threshold Voltage V.S Junction Temperature Fig.6 Resistance V.S Drain Current



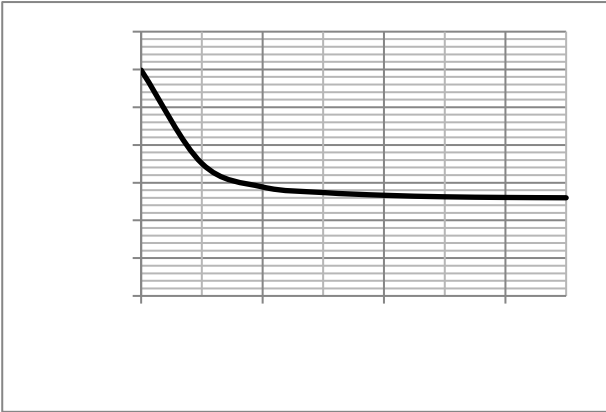

Fig.9 SOA Maximum Safe Operating Area

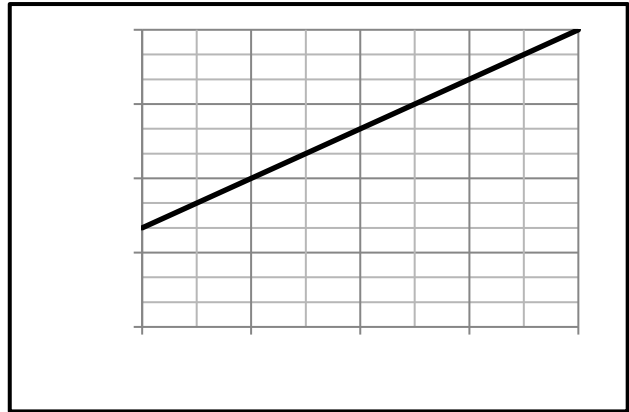

Fig.10 I_D -Junction Temperature

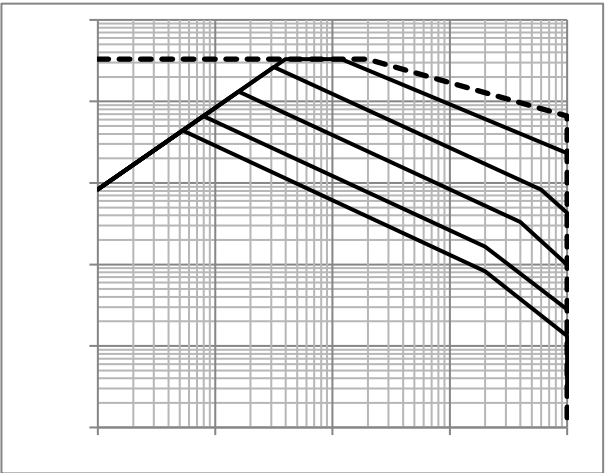

Fig.11 Switching Time Measurement Circuit

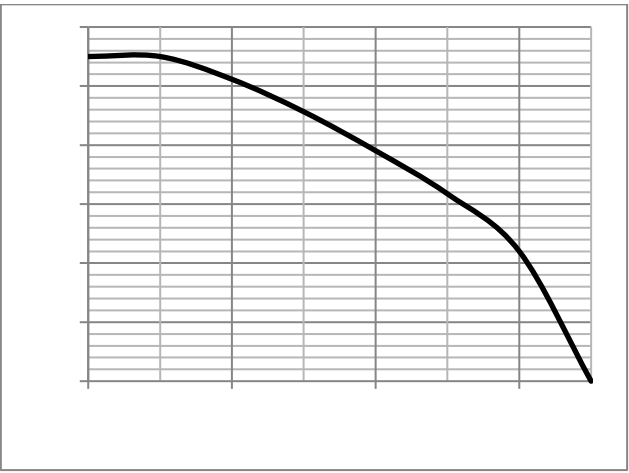

Fig.12 Gate Charge Waveform

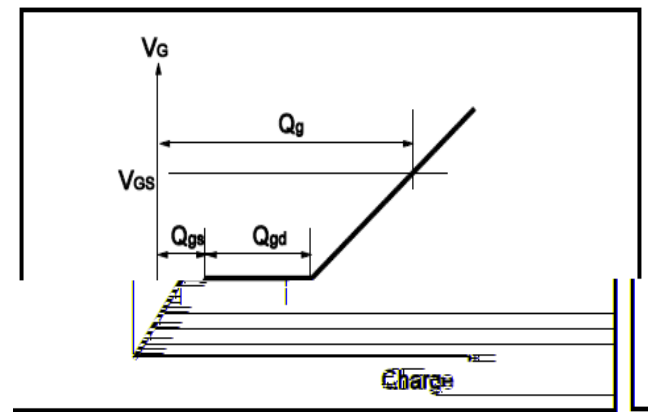
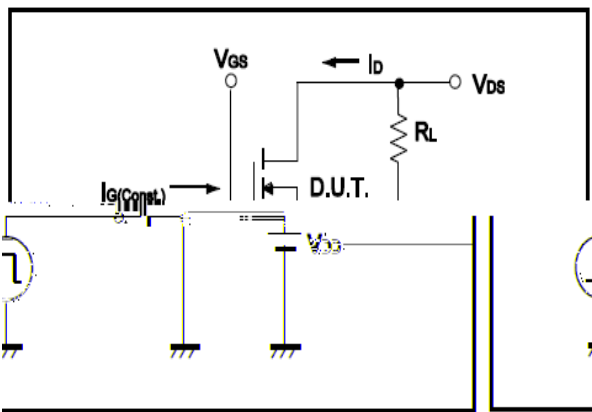

Fig.13 Switching Time Measurement Circuit

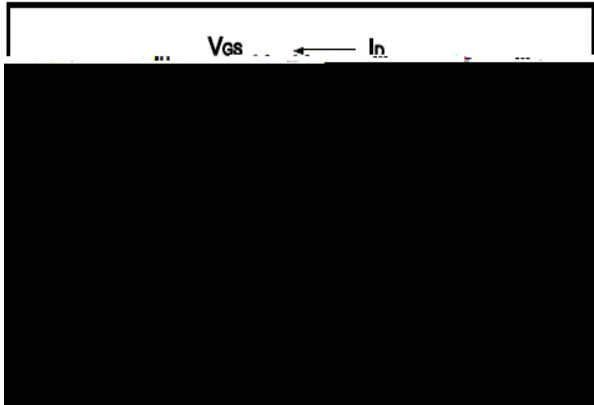

Fig.14 Gate Charge Waveform

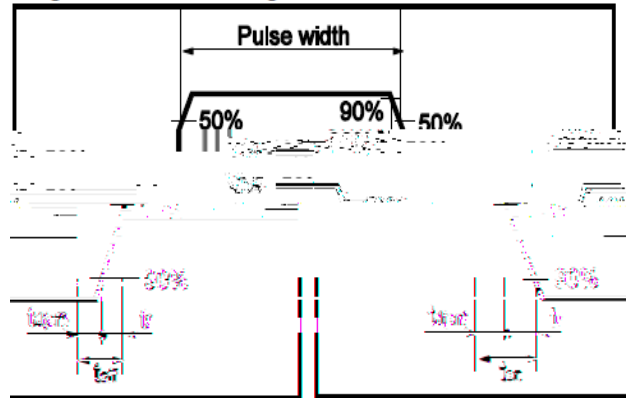

Fig.15 Avalanche Measurement Circuit

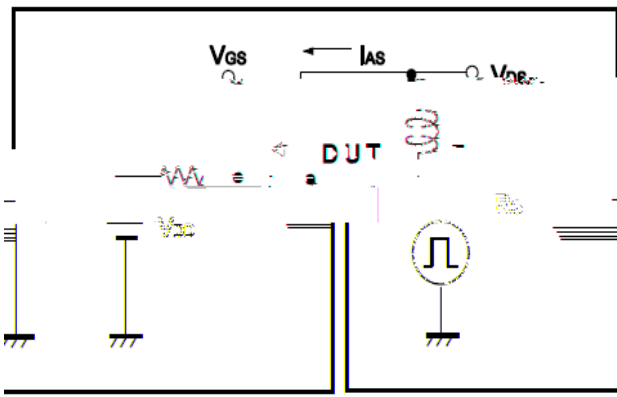
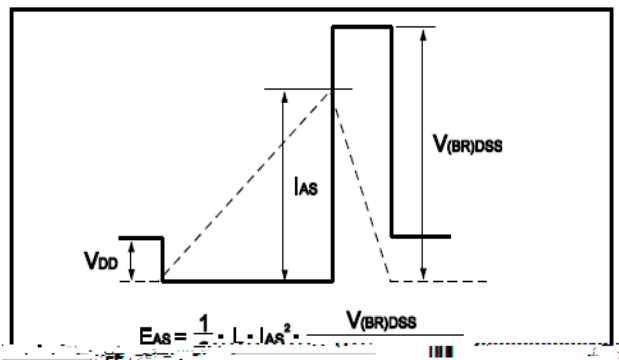

Fig.16 Avalanche Waveform





Dimensions (TO-220)