



Ordering Information:

Absolute Maximum Ratings $T_C = 25$

Parameter	Symbol	Rating	Unit
-----------	--------	--------	------



Turn-ON Rise time		/3		7		ns
Turn-Off Delay (t _{off})	4	/3				

Fig.5 Threshold Voltage V.S Junction Temperature Fig.6 Resistance V.S Drain Current

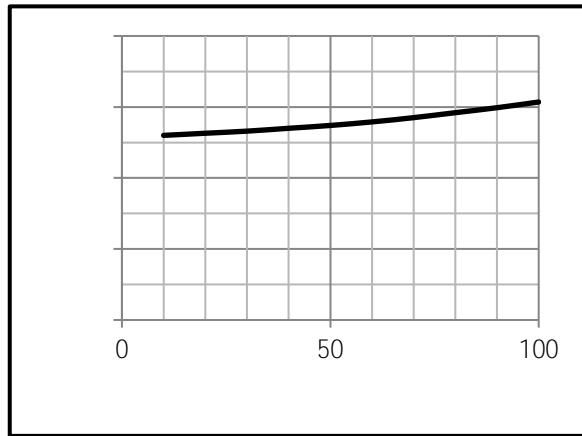
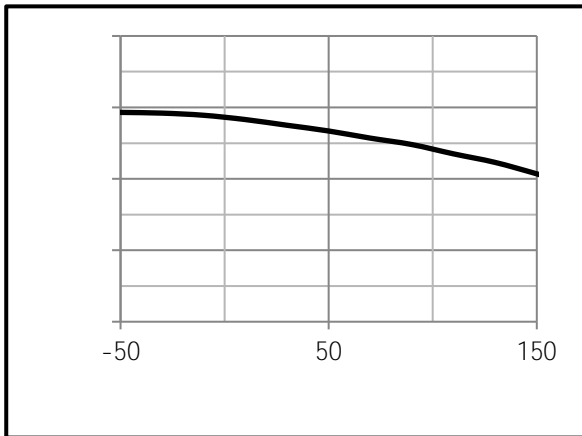

,5

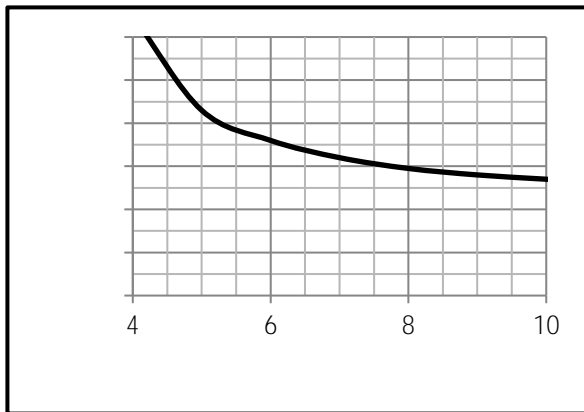

,6

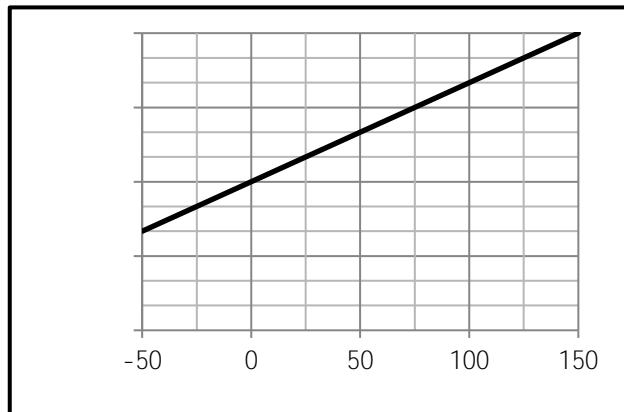

Fig.9 Switching Time Measurement Circuit

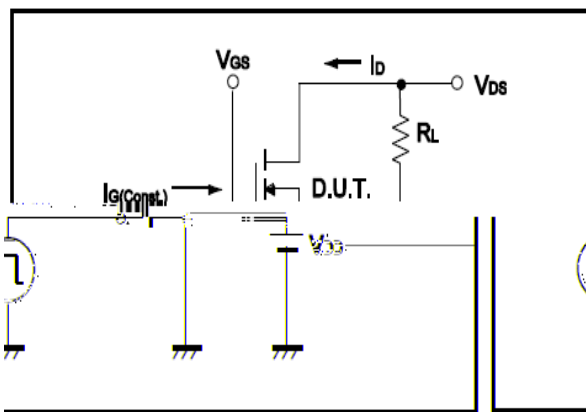

Fig.10 Gate Charge Waveform

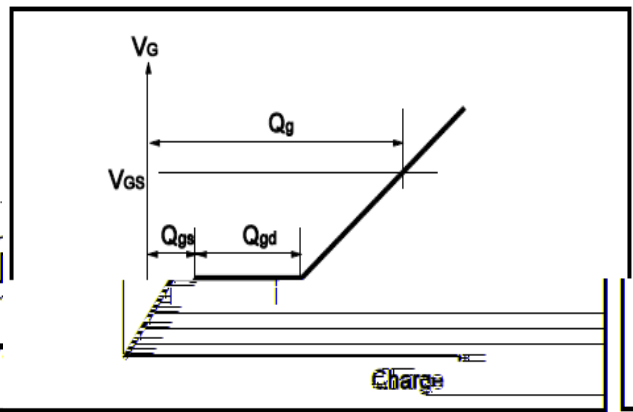

Fig.11 Switching Time Measurement Circuit

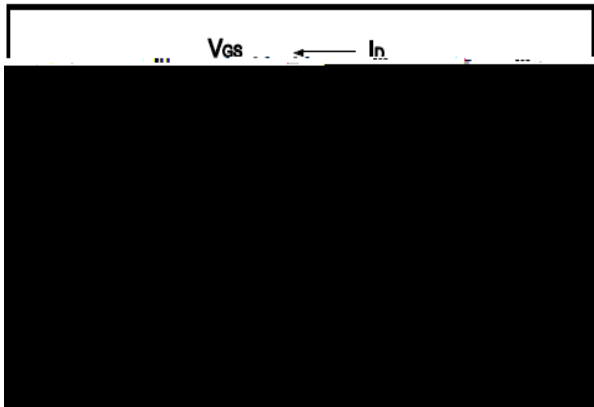

Fig.12 Gate Charge Waveform

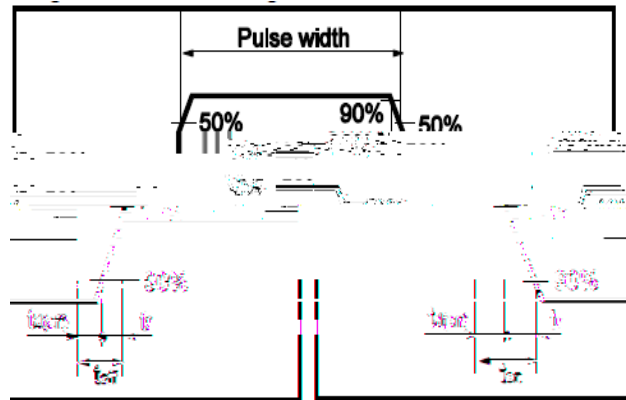

Fig.13 Avalanche Measurement Circuit

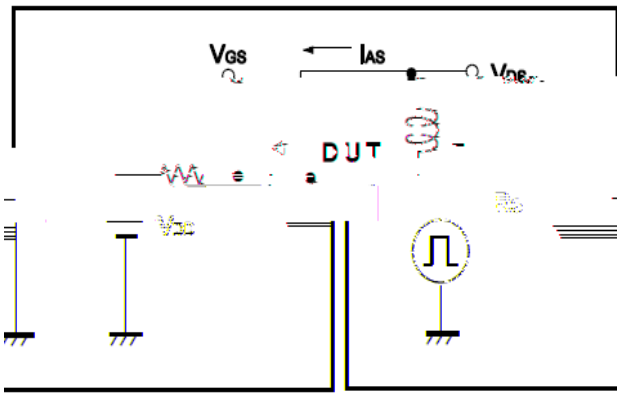

Fig.14 Avalanche Waveform

