

Ordering Information:
Absolute Maximum Ratings $T_C = 25$

Parameter	Symbol	Rating	Unit
Drain-Source Voltage	V_{DS}	65	V
Gate-Source Voltage	V_{GS}	± 20	V
Continuous Drain Current	$I_{D@TC=25}$	10	A
	$I_{D@TC=75}$	7.6	A
	$I_{D@TC=100}$	6.3	A
Pulsed Drain Current	I_{DM}	30	A
Total Power Dissipation	$P_D@TC=25$	3.6	W
Total Power Dissipation	$P_D@TA=25$	0.69	W
Operating Junction Temperature	T_J		

Fig.1 Gate-Charge Characteristics

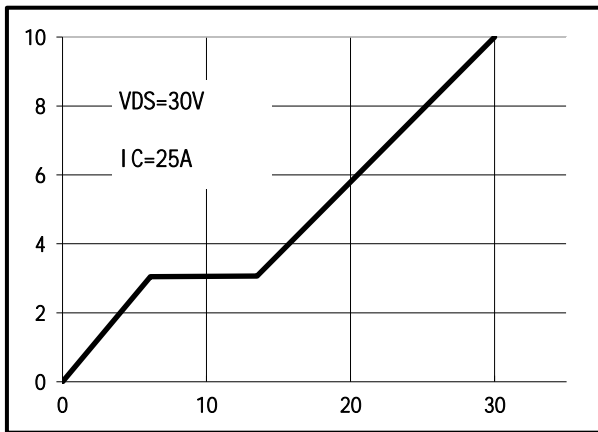

Fig.2 Capacitance Characteristics

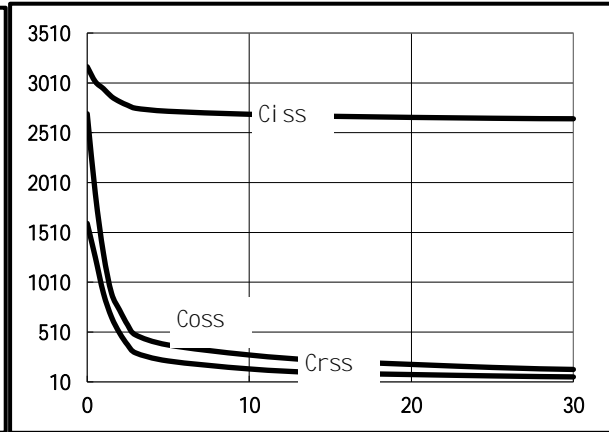

Fig.3 Power Dissipation

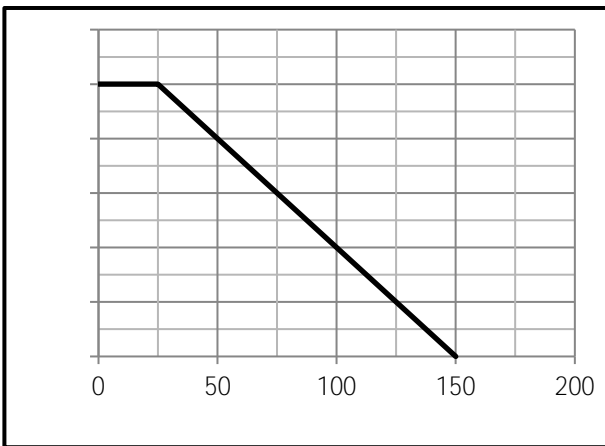

Fig.4 Typical output Characteristics

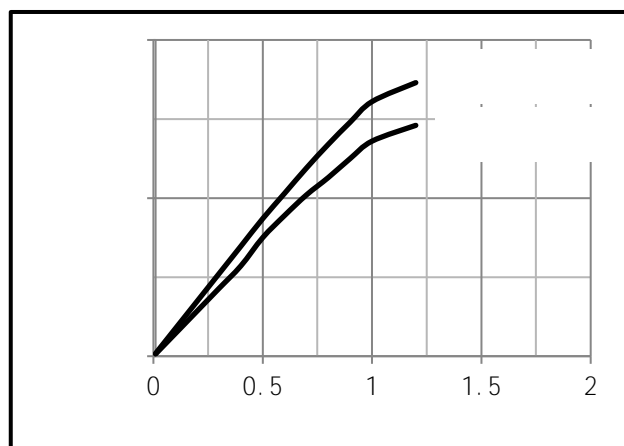

Fig.5 Threshold Voltage V.S Junction Temperature

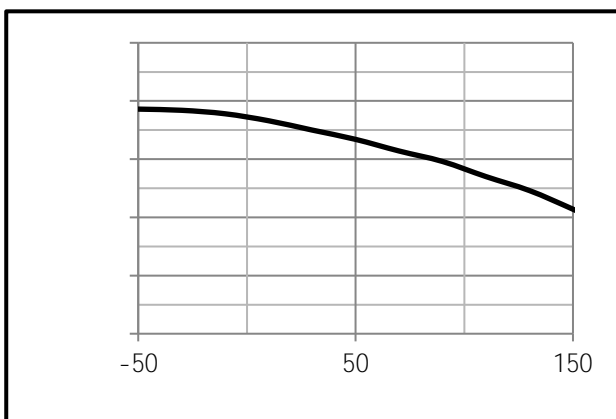
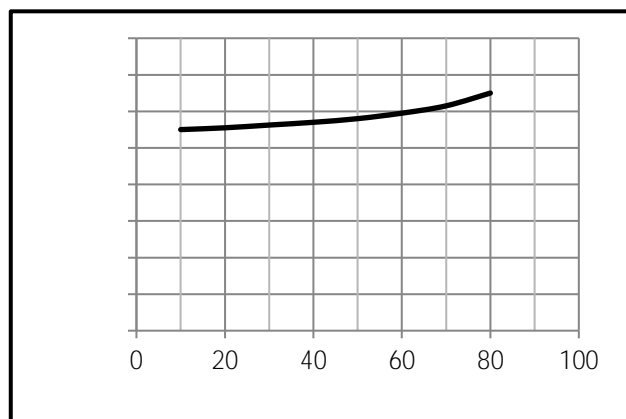

Fig.6 Resistance V.S Drain Current



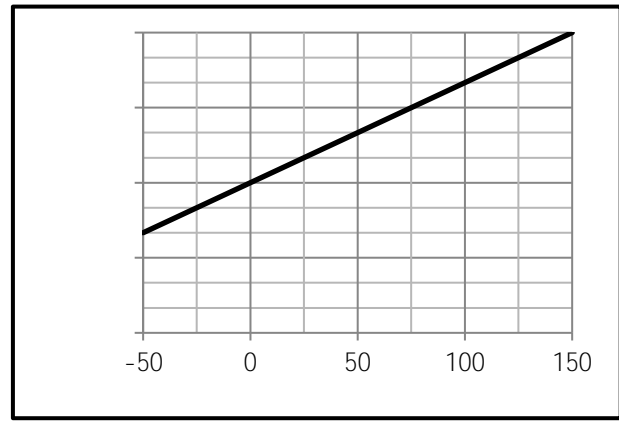
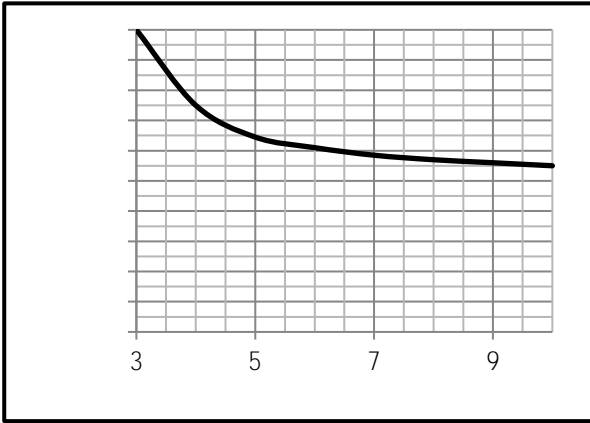

Fig.9 Switching Time Measurement Circuit

Fig.10 Gate Charge Waveform

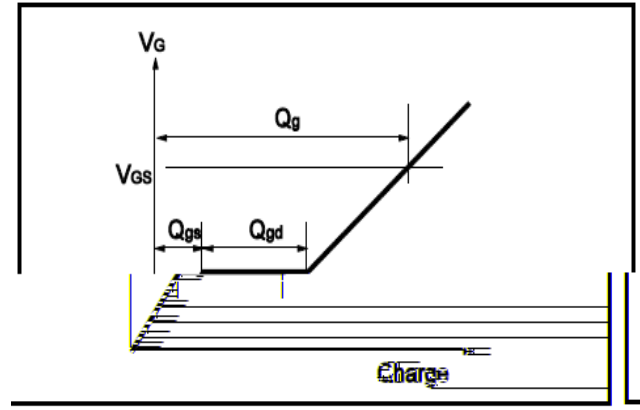
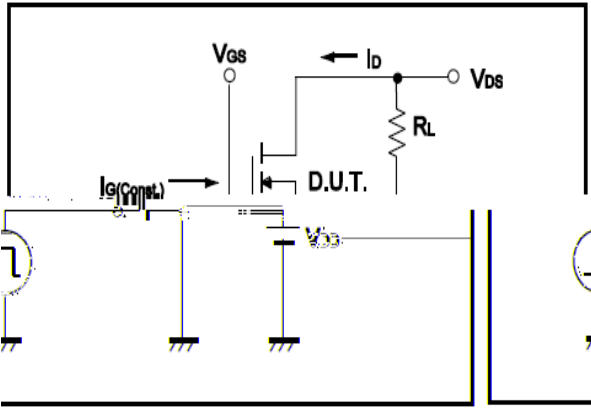

Fig.11 Switching Time Measurement Circuit

Fig.12 Gate Charge Waveform

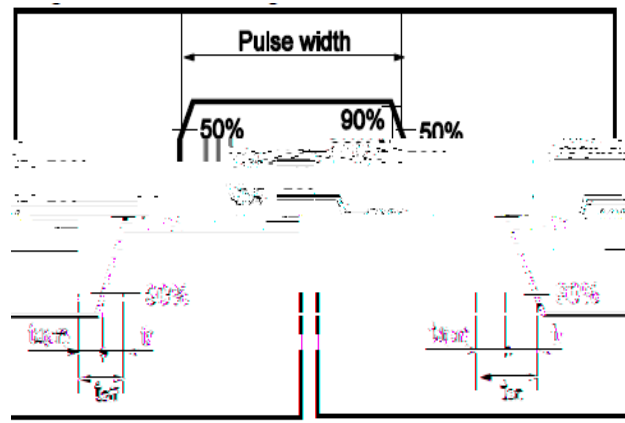
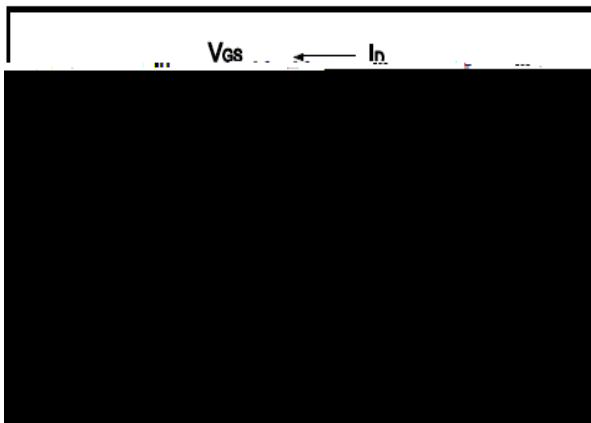

Fig.13 Avalanati Measurement Circuit

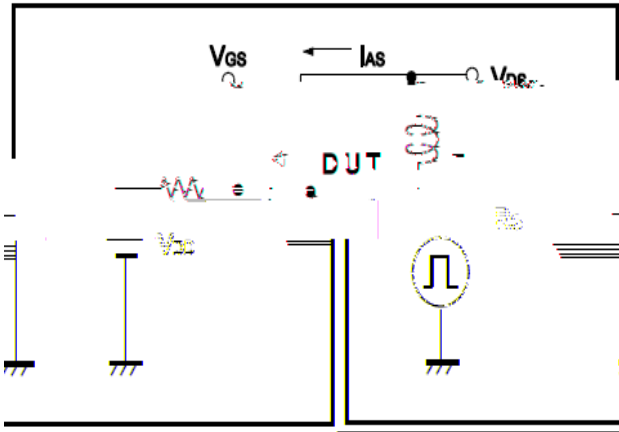
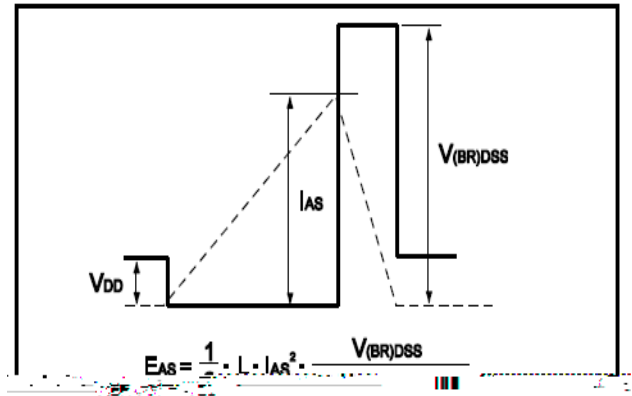

Fig.14 Avalanati Waveform



Dimensions(SOP8)

Unit: mm

SYMBOL	min	TYP	max	SYMBOL	min		max
A	4.80		5.25	C	1.30		1.75
A1	0.37		0.49	C1	0.55		0.75
A2		1.27		C2	0.55		0.65
A3		0.41		C3	0.05		0.20
B	5.80		6.20	C4	0.10	0.20	0.23
B1	3.80		4.10	D		1.05	
B2		5.00		D1	0.40		0.62

